



**CARATTERISTICHE COSTRUTTIVE / CONSTRUCTION FEATURES
CARACTERISTICAS CONSTRUCTIVAS / CARACTÉRISTIQUES D'EXÉCUTION**

Corpo pompa	ghisa
Pump body	cast iron
Cuerpo bomba	fundición
Corps de pompe	fonte
Supporto motore	ghisa
Motor bracket	cast iron
Soporte motor	fundición
Support moteur	fonte
Girante	ghisa, bronzo o acciaio
Impeller	cast iron, bronze or stainless steel
Rodete	fundición, bronce o acero
Turbine	fonte, bronze ou acier
Tenuta meccanica	ceramica-grafite
Mechanical seal	ceramic-graphite
Sello mecánico	cerámica-grafito
Garniture mécanique	céramique-graphite
Sporgenza albero motore	acciaio AISI 304
Pump shaft end	stainless steel AISI 304
Bomba eje	acero AISI 304
Pompe arbre	acier AISI 304
Temperatura del liquido	
Liquid temperature	-10 ÷ +90 °C
Temperatura del liquido	
Température du liquide	
Pressione di esercizio	
Operating pressure	max 10 bar
Presión de trabajo	
Pression de fonctionnement	

MOTORE / MOTOR / MOTOR / MOTEUR

Motore 2 poli a induzione	3~ 230/400V-50Hz P ≤ 4kW
2 pole induction motor	3~ 400/690V-50Hz P > 4kW
Motor de 2 polos a inducción	
Moteur à induction à 2 pôles	1~ 230V-50Hz
Classe di isolamento	
Insulation class	F
Clase de aislamiento	
Classe d'isolation	
Grado di protezione	
Protection degree	IP55
Grado de protección	
Protection	

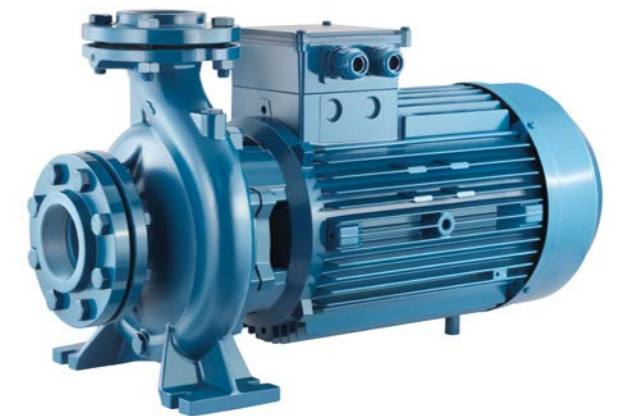

Pompe centrifughe monoblocco ad asse orizzontale costruite secondo le norme EN 733; trovano vasto utilizzo nell'alimentazione idrica, negli impianti di pressurizzazione e antincendio, raffreddamento, riscaldamento, irrigazione, applicazioni agricole e industriali; come standard vengono fornite di controflangia.

Monobloc horizontal centrifugal pumps, constructed to EN 733 standards; widely used in water supplies, pressurisation and fire-fighting systems, cooling, heating, irrigation, industrial and agricultural applications; standard supply with counter-flange.

Bombas centrifugas monobloque de eje horizontal fabricadas según las normas EN 733; se utilizan en gran parte en la alimentación hídrica, en las instalaciones de presurización y antiincendio, enfriamiento, calefacción, riego, aplicaciones agrícolas e industriales; según el estándar se suministran con contrabrida.

Pompes centrifuges monobloc à axe horizontal, fabriquées conformément aux normes EN 733. Elles trouvent une ample utilisation dans l'approvisionnement d'eau, dans les installations de pressurisation et anti-incendie, refroidissement, chauffage, irrigation, applications agricoles et industrielles; fournies de série avec contre-bride.

32-160

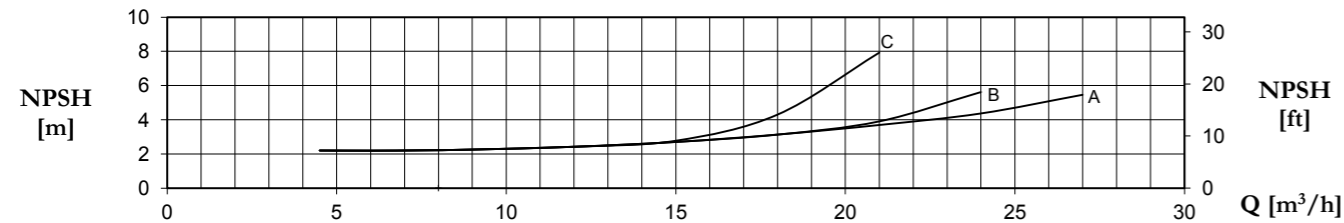
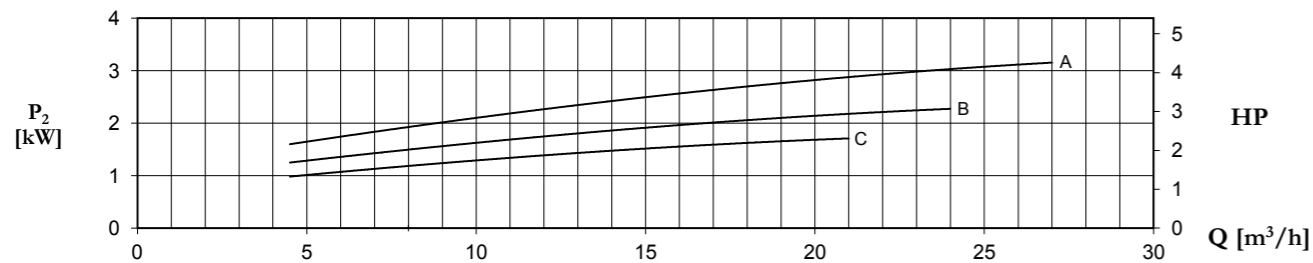
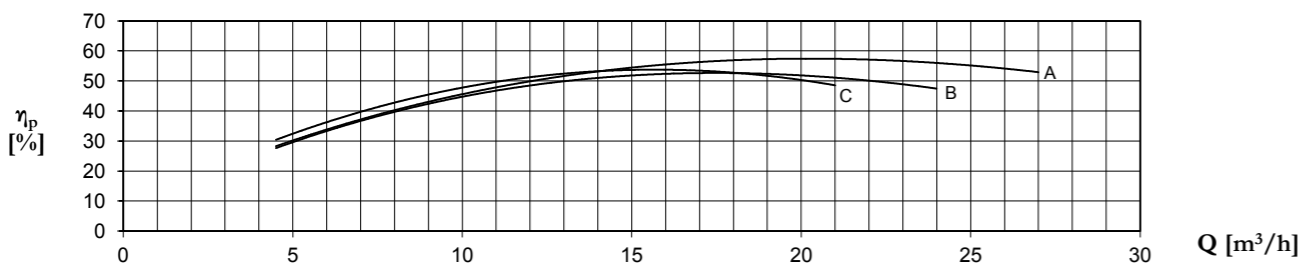
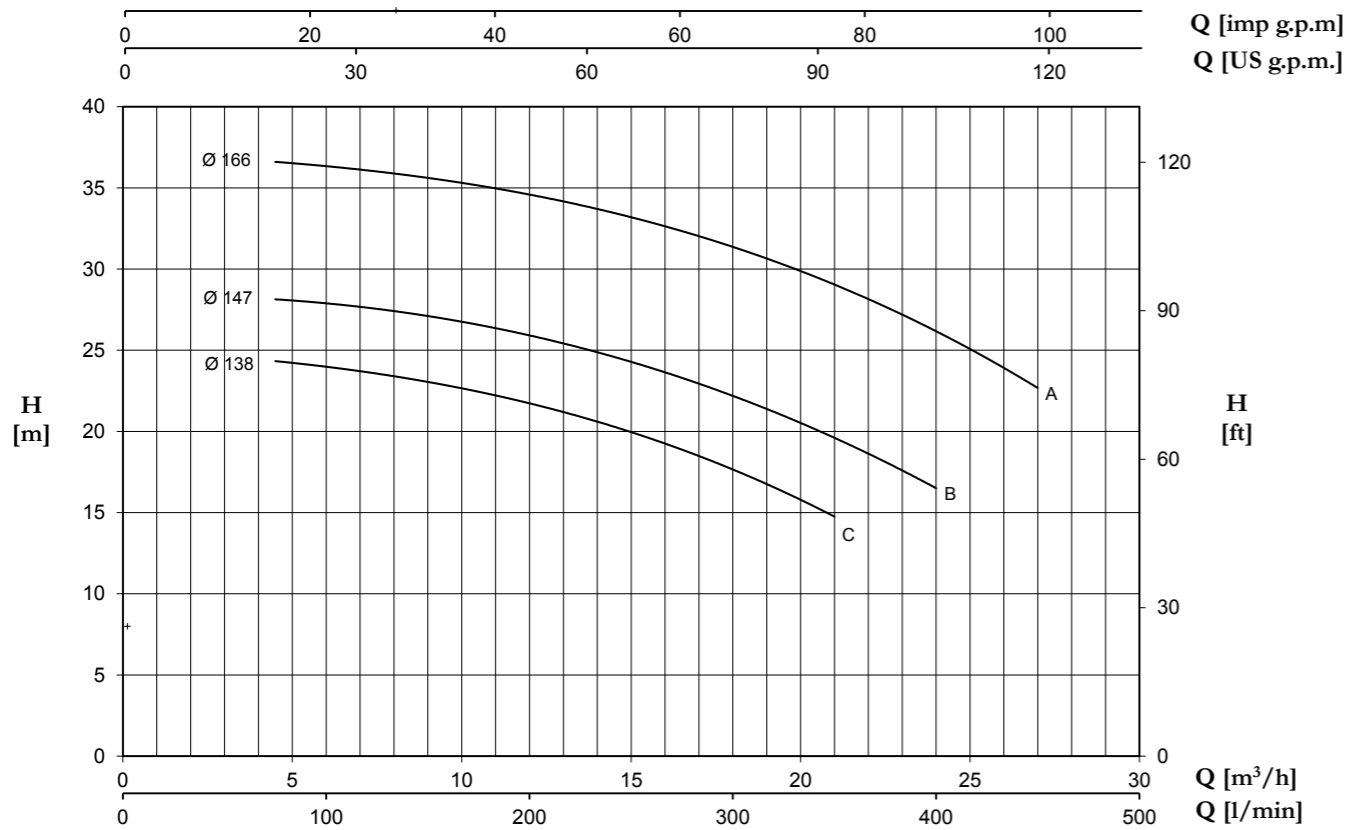

Tolerance: ISO 9906:2012 - Grade 3B

TYPE		P2		P1 (kW)		A		Q (m³/h - l/min)									
1~	3~	(HP)	(kW)	1~	3~	Q (m³/h - l/min)											
						0	4,5	6	9	12	15	18	21	24	27		
						0	75	100	150	200	250	300	350	400	450		
						H (m)											
						1x230V 50 Hz	3x400V 50 Hz										
32-160 Cm	32-160 C	2	1,5	2,3	2,2	10,8	3,6	24,4	24,3	24,0	23,0	21,8	20,0	17,5	14,8	-	-
32-160 Bm	32-160 B	3	2,2	2,8	2,8	13,0	5,0	28,1	28,2	27,9	27,0	25,9	24,4	22,2	19,5	16,6	-
-	32-160 A	4	3	-	3,8	-	6,8	36,8	36,6	36,4	35,6	34,5	33,2	31,5	29,1	26,0	22,8

32-200

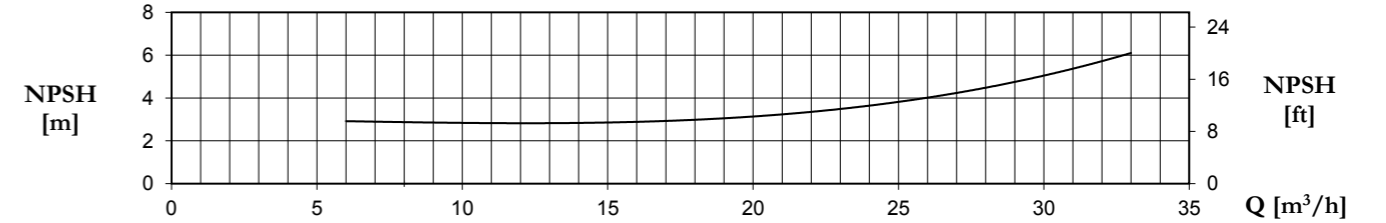
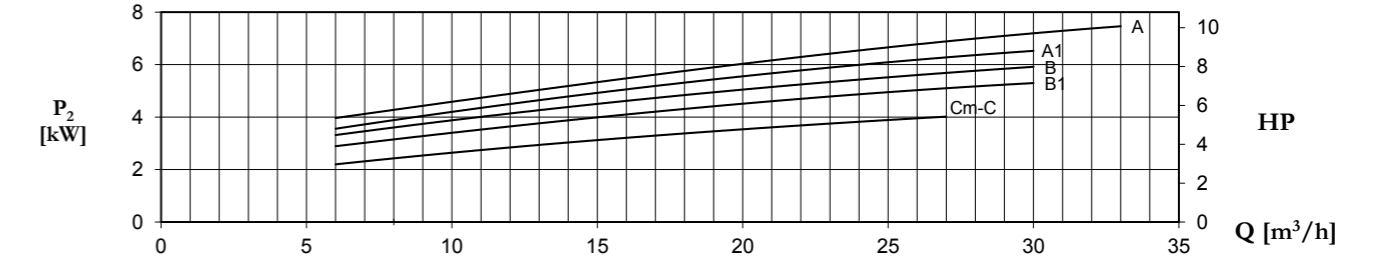
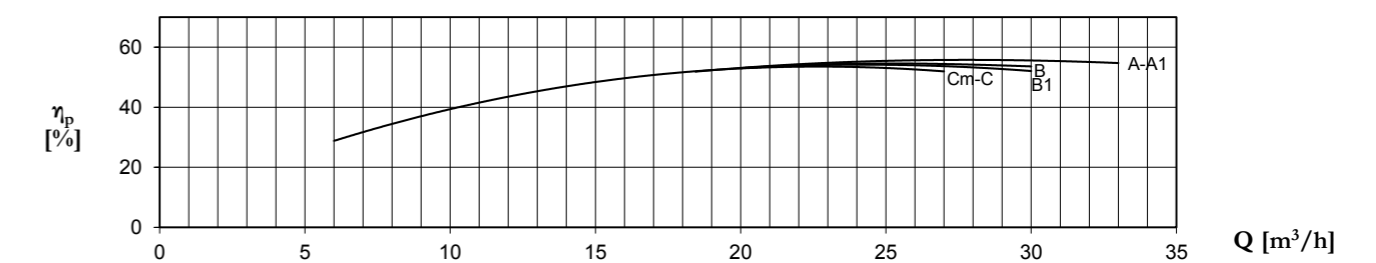
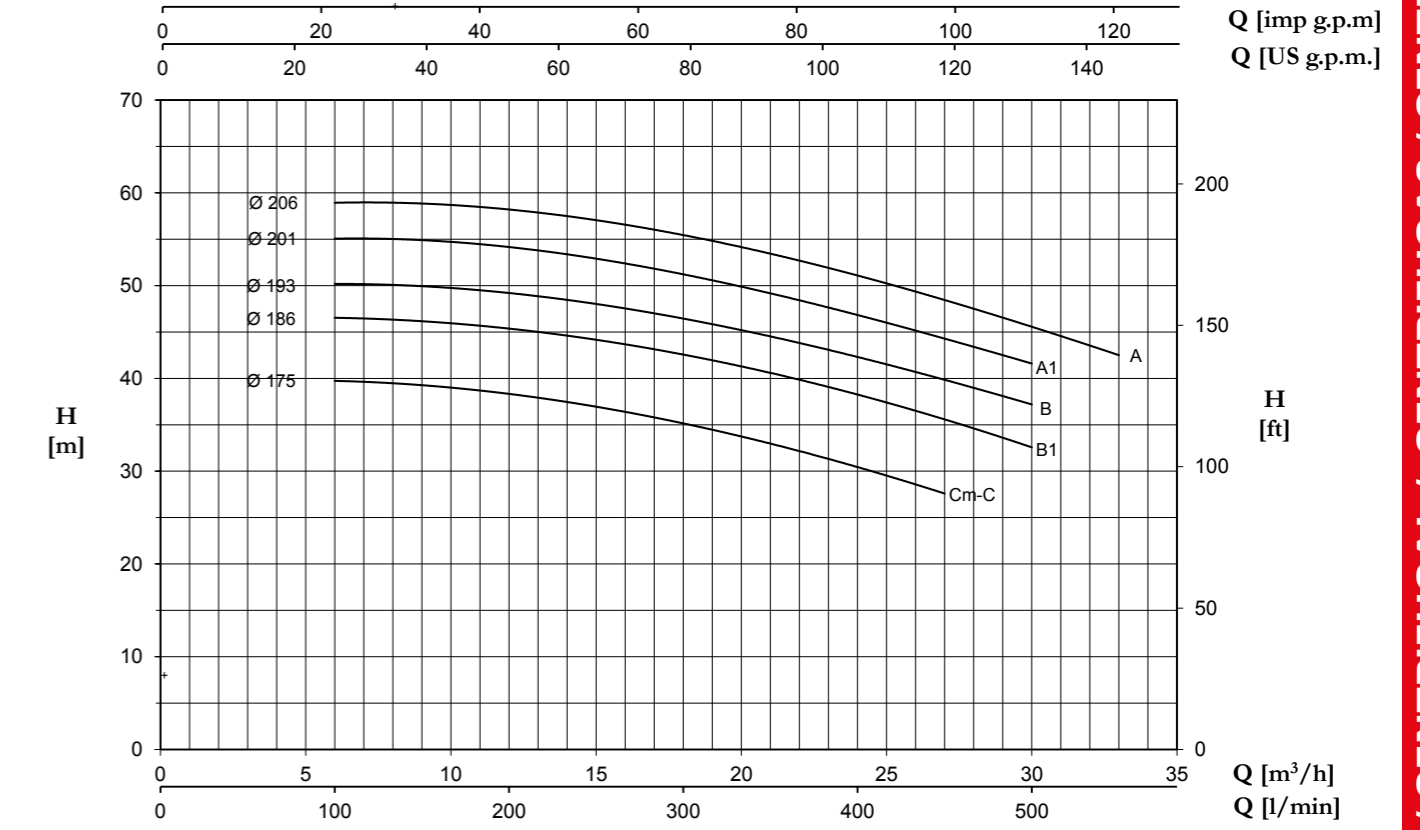

Tolerance: ISO 9906:2012 - Grade 3B

TYPE		P2		P1 (kW)		A		Q (m³/h - l/min)									
1~	3~	(HP)	(kW)	1~	3~	A		Q (m³/h - l/min)									
						1~	3~	0	6	9	12	15	21	24	27	30	33
						1x230V 50 Hz	3x400V 50 Hz	H (m)									
32-200 Cm	-	5,5	4,0	5,3	-	24	-	40,1	39,7	39,3	38,3	36,9	33,0	30,4	27,6	-	-
-	32-200 C	5,5	4,0	-	4,9	-	8,8	40,1	39,7	39,3	38,3	36,9	33,0	30,4	27,6	-	-
-	32-200 B1	7,5	5,5	-	6,3	-	11,1	46,4	46,5	46,2	45,4	44,2	40,5	38,3	35,7	32,5	-
-	32-200 B	7,5	5,5	-	7,0	-	12,4	50,1	50,2	49,9	49,3	48,0	44,5	42,4	39,8	37,2	-
-	32-200 A1	10	7,5	-	7,5	-	13,1	55,1	55,1	54,9	54,2	52,9	49,2	46,8	44,3	41,6	-
-	32-200 A	10	7,5	-	8,5	-	15,0	58,6	59,0	58,8	58,2	57,1	53,4	51,1	48,4	45,6	42,5

32-250

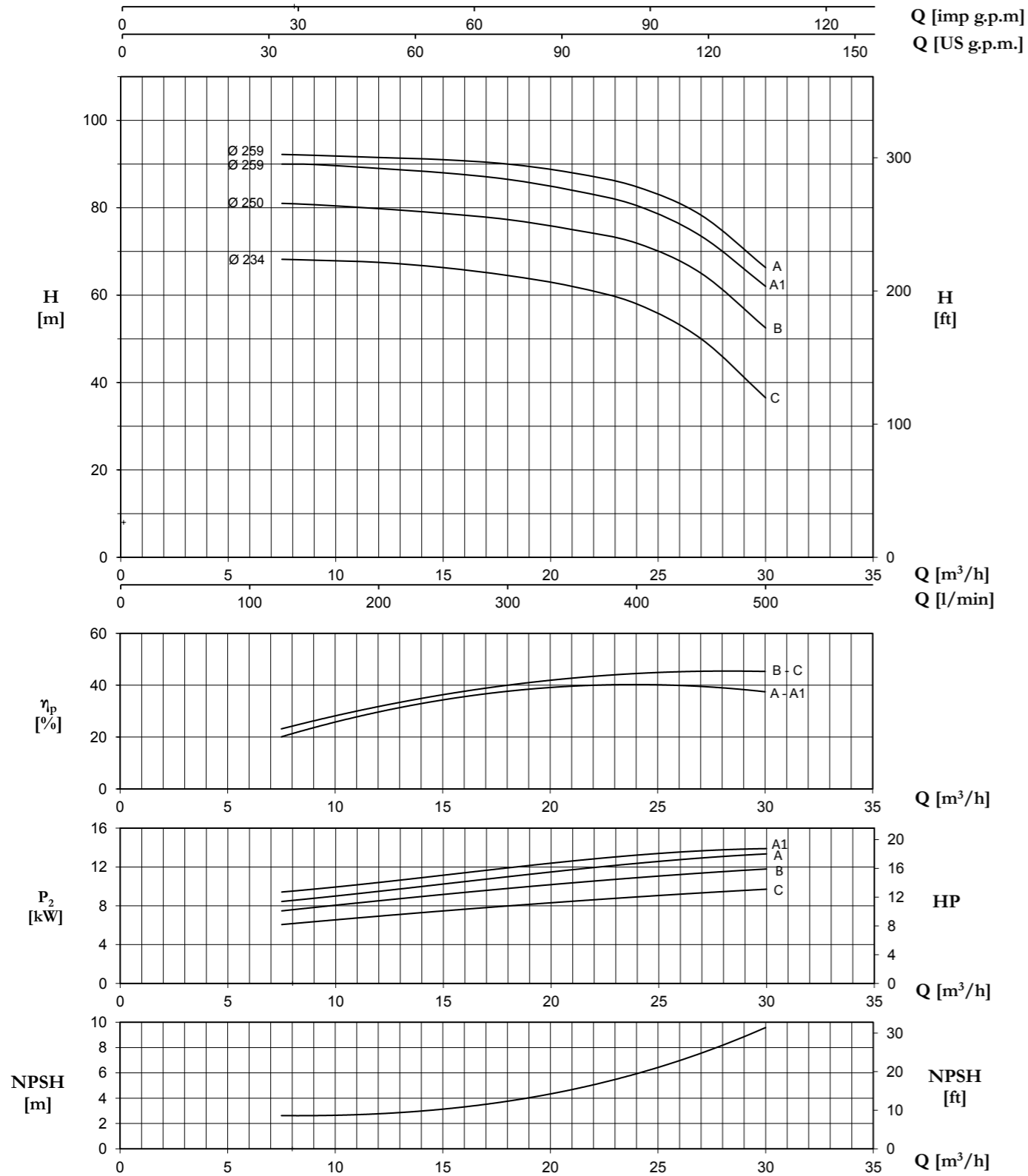

Tolerance: ISO 9906:2012 - Grade 3B

TYPE	P2		P1 (kW)	Q (m³/h - l/min)										
				H (m)										
				0	7,5	9	12	15	18	21	24	27	30	
3~	(HP)	(kW)	3~	3~	0	125	150	200	250	300	350	400	450	500
				3x400 V 50 Hz	0	125	150	200	250	300	350	400	450	500
32-250 C	12,5	9,2	11,9	20,1	70,0	68,5	68	67	65,5	63,5	61	58	50	36,5
32-250 B	15	11	14,4	24,2	82,0	81	80,5	79,5	78,5	77	74,5	71,9	65	52,5
32-250 A1	20	15	16	27,4	91,0	90	89,9	89	88	86	83,5	80,8	74	61,5
32-250 A	20	15	18,1	30,1	93,0	92,5	92	91,5	90,5	89,5	87,5	85	78,5	66

40-125

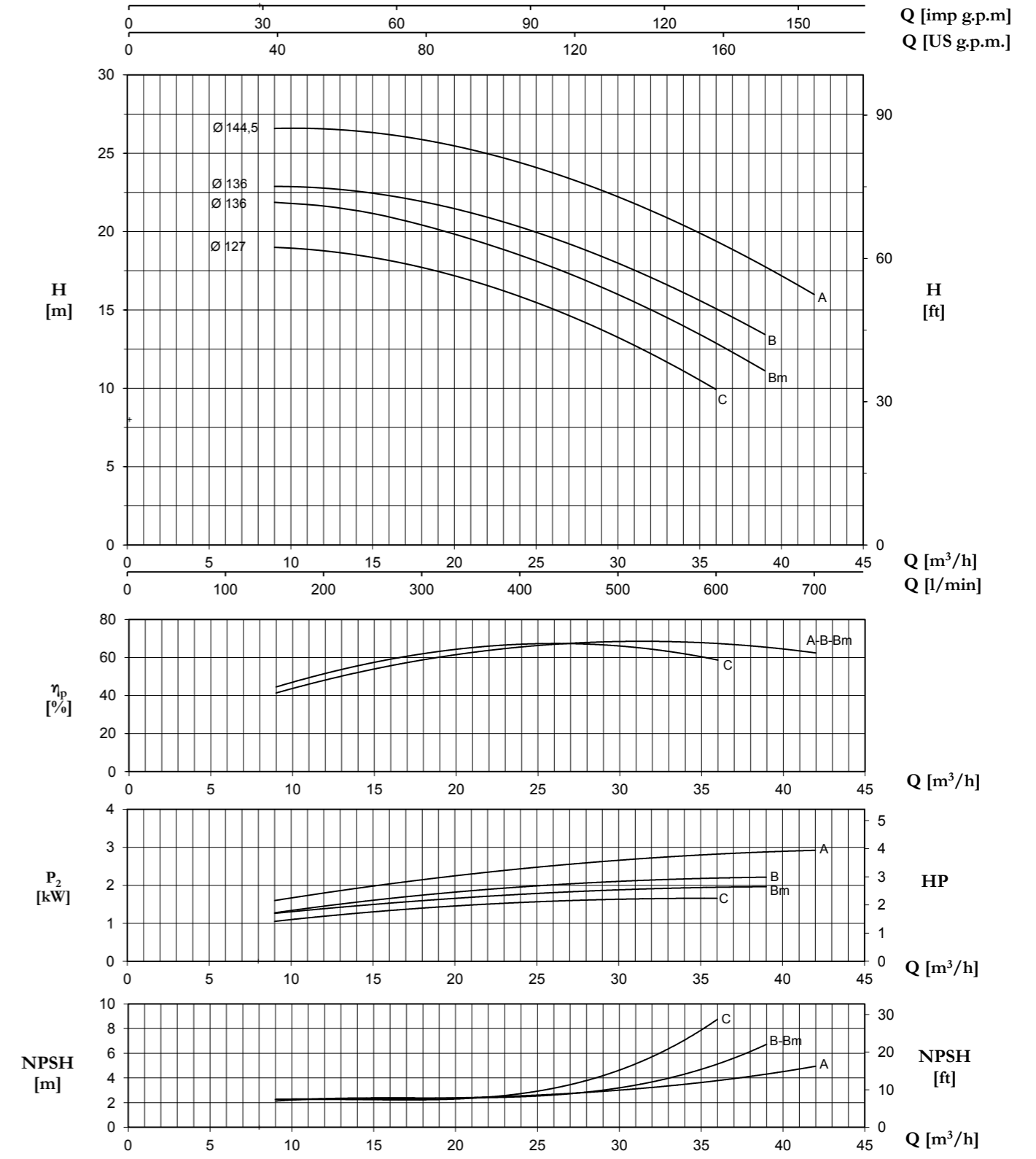

Tolerance: ISO 9906:2012 - Grade 3B

TYPE	P2		P1 (kW)	Q (m³/h - l/min)															
				H (m)															
				0	9	15	21	27	30	33	36	39	42						
1~	(HP)	(kW)	1~	1~	0	150	250	350	450	500	550	600	650	700					
				3~	0	150	250	350	450	500	550	600	650	700					
40-125 C	2	1,5	2,2	2,2	10	3,6	18,9	19	18,3	16,9	14,7	13,2	11,6	9,9	-	-			
-	40-125 B	3	2,2	-	2,7	-	4,8	22,5	22,9	22,5	21,2	19,2	18	16,7	15,2	13,4	-		
40-125 Bm	-	3	2,2	2,7	-	12,2	-	21,9	21,9	21,2	19,5	17,3	16	14,5	12,9	11,1	-		
-	40-125 A	4	3	-	3,5	-	6,4	26,2	26,6	26,3	25,2	23,4	22,2	20,9	19,4	17,8	16		

40-160

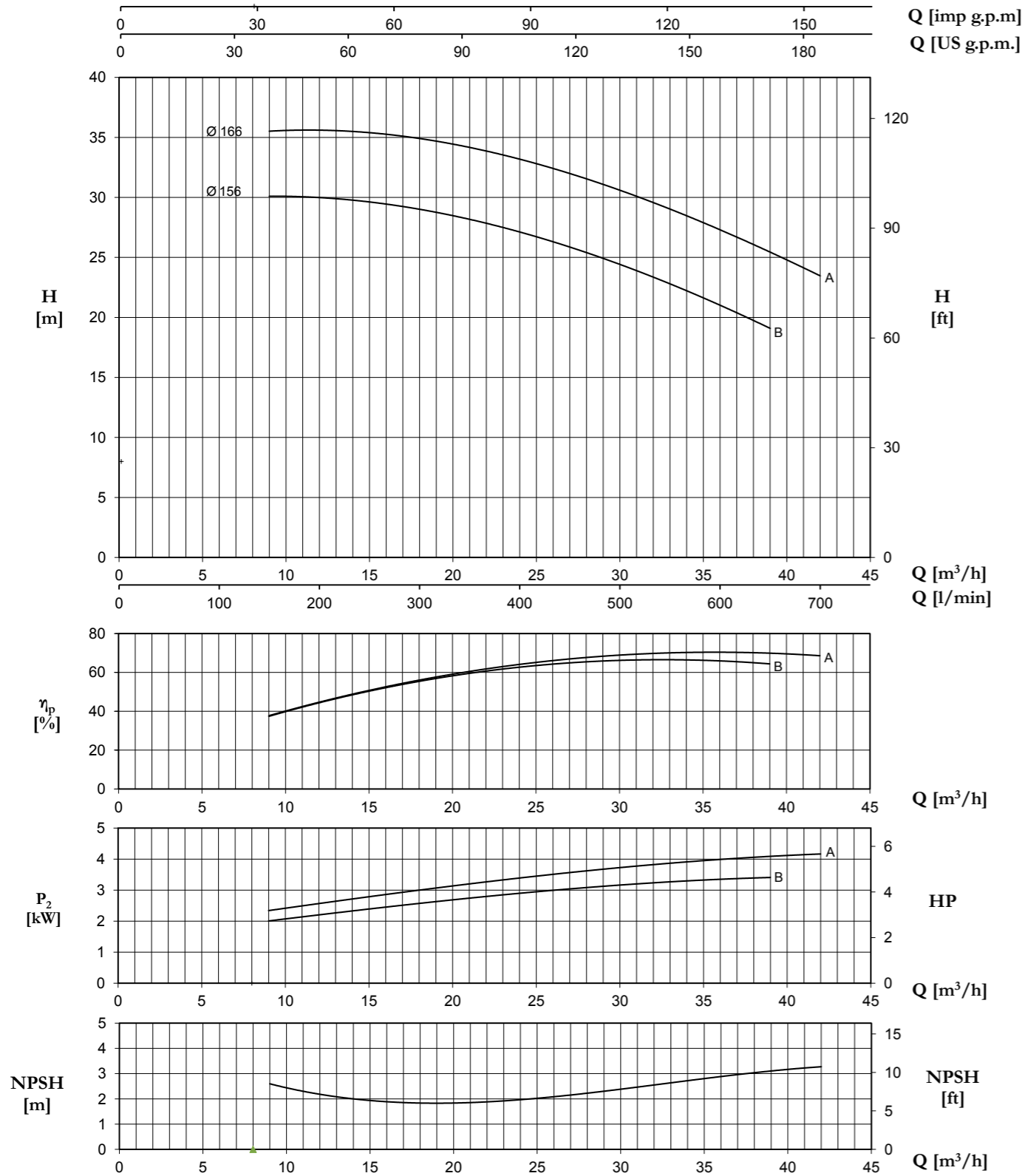

Tolerance: ISO 9906:2012 - Grade 3B

TYPE		P2		P1 (kW)		Q (m³/h - l/min)															
1~	3~	(HP)	(kW)	1~	3~	A															
						Q (m³/h - l/min)		H (m)													
						0	9	12	15	18	21	24	27	30	33	36	39	42			
						0	150	200	250	300	350	400	450	500	550	600	650	700			
40-160 B	40-160 B	4	3	4,3	4,2	19,0	7,2	30,0	30,1	30,0	29,6	29,0	28,2	27,1	25,9	24,4	22,8	21,0	19,1	-	
40-160 A	40-160 A	5,5	4	5,4	5,1	24,5	9,2	35,4	35,6	35,5	35,3	35,0	34,2	33,2	32,0	30,6	29,0	27,3	25,4	23,5	

40-200

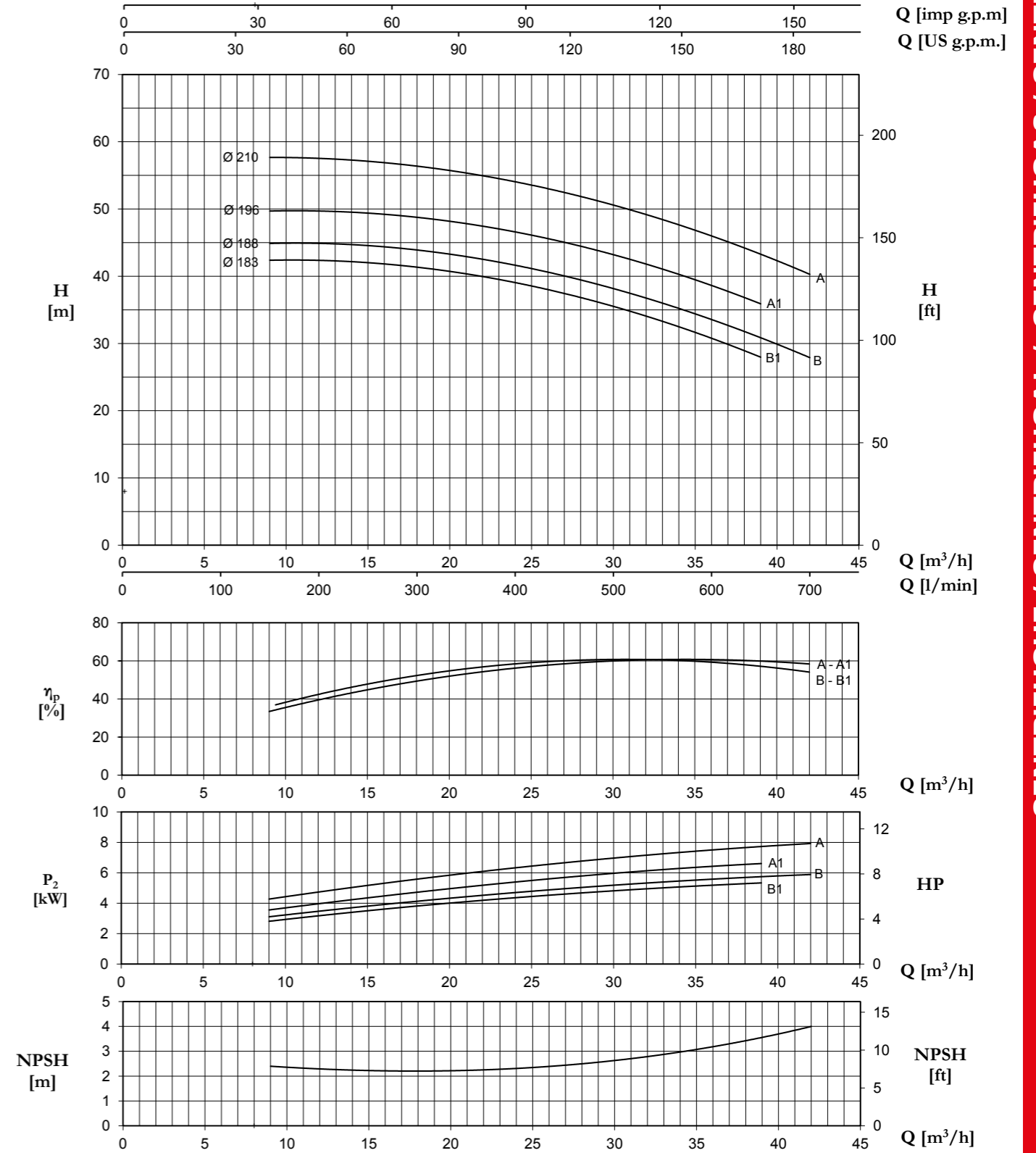

Tolerance: ISO 9906:2012 - Grade 3B

TYPE	P2		P1 (kW)	A	Q (m³/h - l/min)															
	3~	3~			H (m)															
3~	(HP)	(kW)	3~	3~	0	9	12	15	18	21	24	27	30	33	36	39	42			
					0	150	200	250	300	350	400	450	500	550	600	650	700			
40-200 B1	7,5	5,5	6,5	11,1	42,2	42,4	42,3	42,1	41,3	40,3	39,1	37,5	35,5	33,3	30,7	28,0	-			
40-200 B	7,5	5,5	7,4	12,7	44,7	44,9	44,8	44,6	44,0	42,9	41,6	40,0	38,1	36,1	33,6	30,8	27,9			
40-200 A1	10	7,5	8,1	13,8	49,7	49,7	49,7	49,4	48,7	47,9	46,6	45,0	43,2	41,1	38,6	35,9	-			
40-200 A	10	7,5	9,8	16,5	57,7	57,7	57,5	57,1	56,3	55,4	54,1	52,5	50,5	48,5	45,9	43,3	40,3			

40-250

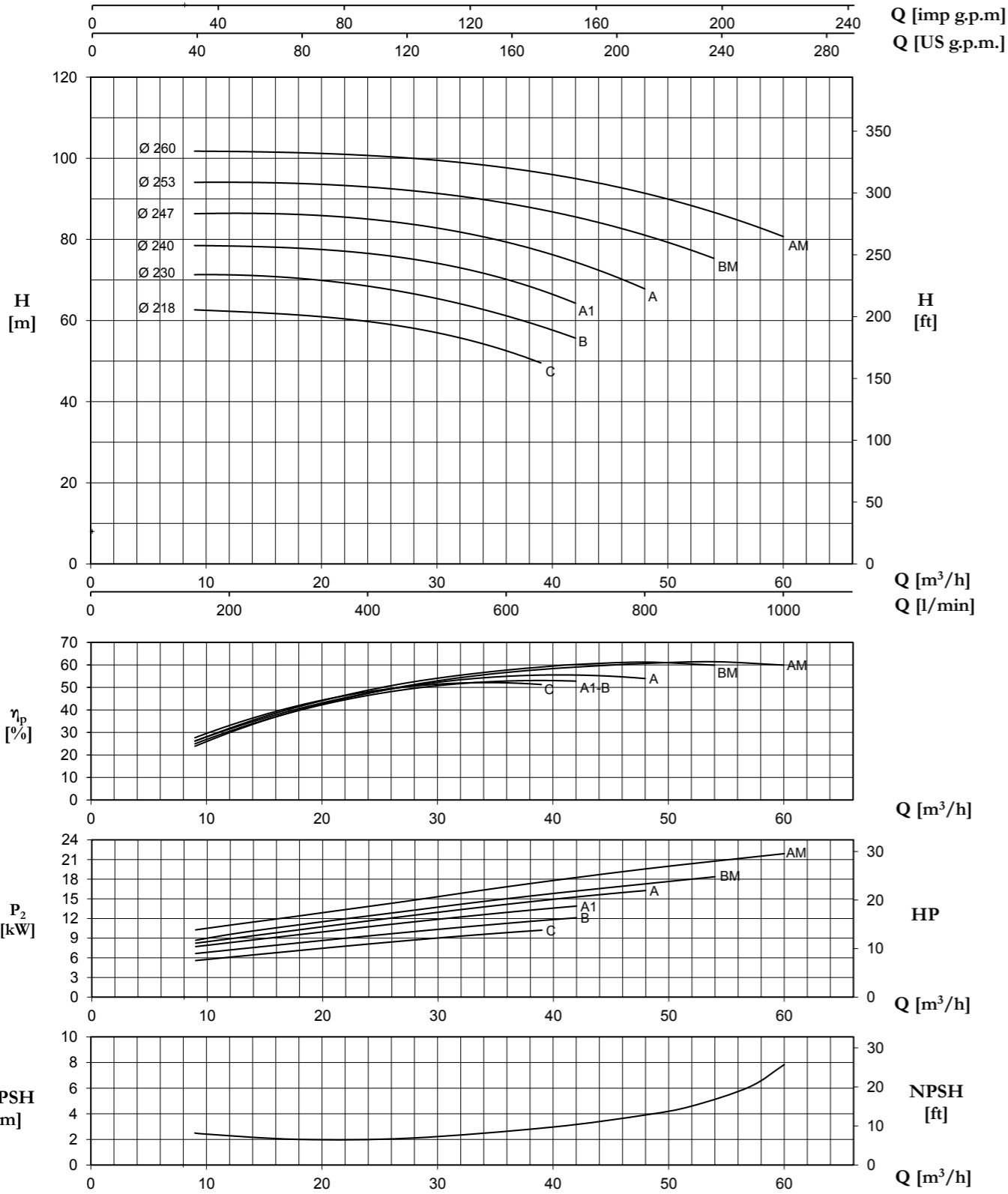

Tolerance: ISO 9906:2012 - Grade 3B

TYPE	P2		P1 (kW)	Q (m³/h - l/min)												
				A	Q (m³/h - l/min)											
					3~	0	9	18	24	30	39	42	48	54	60	
3~	(HP)	(kW)	3~	3x400 V 50 Hz	H (m)											
40-250 C	12,5	9,2	11,9	20,2	63,0	62,6	61,3	59,7	57,1	49,6	-	-	-	-		
40-250 B	15	11	14	23,9	70,8	71,3	70,5	68,4	65,4	58,5	55,6	-	-	-		
40-250 A1	20	15	15,9	26,9	77,9	78,5	77,8	76,6	74,1	67,4	64,3	-	-	-		
40-250 A	20	15	19	31,3	86,1	86,3	86,0	85,0	82,9	77,0	74,3	67,9	-	-		
40-250BM*	25	18,5	22	38	93,1	93,8	93,8	92,9	91,3	87,3	85,6	81,4	75,1	-		
40-250AM*	30	22	26	43	101,6	101,9	101,2	100,7	99,7	96,3	94,6	91,2	87,0	80,6		

(*) : max 14 bar

50-125

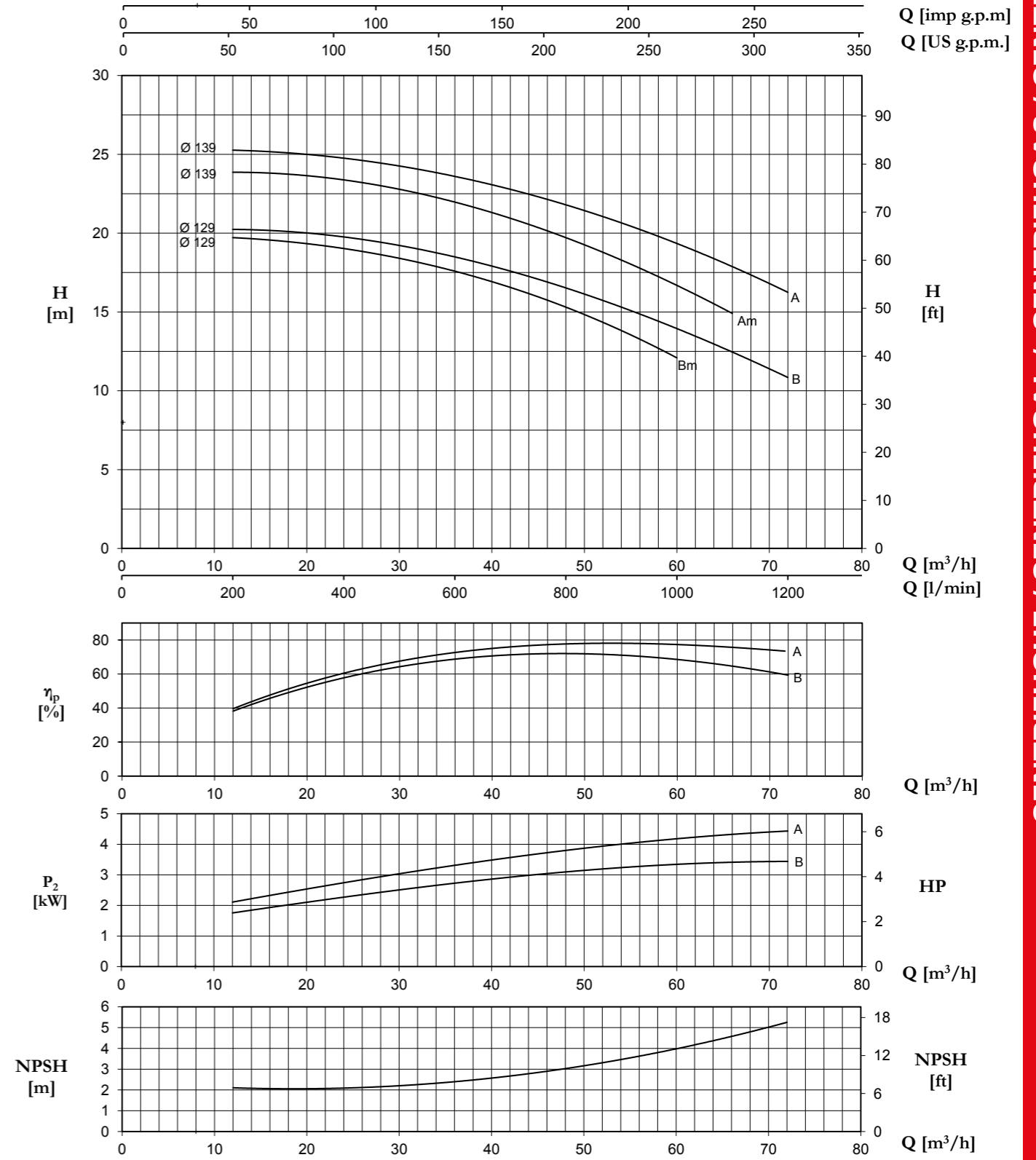

Tolerance: ISO 9906:2012 - Grade 3B

TYPE	P2		P1 (kW)	AMPERE		Q (m³/h - l/min)																	
						Q (m³/h - l/min)																	
						1~	3~	0	12	15	18	21	24	27	30	33	36	39	42	48	54	60	66
1~	3~	(HP)	(kW)	1~	3~	H (m)																	
-	50-125 B	4	3	1~	3~	19,8	20,2	20,2	20,1	20	19,8	19,5	19,3	18,8	18,5	18	17,6	16,5	15,3	14	12,5	10,8	
50-125 B m	-	4	3	1~	3~	19,5	19,7	19,6	19,5	19,3	19	18,7	18,4	18	17,6	17,1	16,6	15,3	13,8	12,1	-	-	
-	50-125 A	5,5	4	1~	3~	24,8	25,2	25,2	25,1	25	24,8	24,6	24,3	23,9	23,5	23,2	22,7	21,8	20,7	19,4	17,9	16,2	
50-125 A m	-	5,5	4	1~	3~	23,7	23,9	23,8	23,7	23,6	23,4	23,1	22,8	22,4	22	21,5	20,9	19,7	18,3	16,7	14,9	-	

50-160

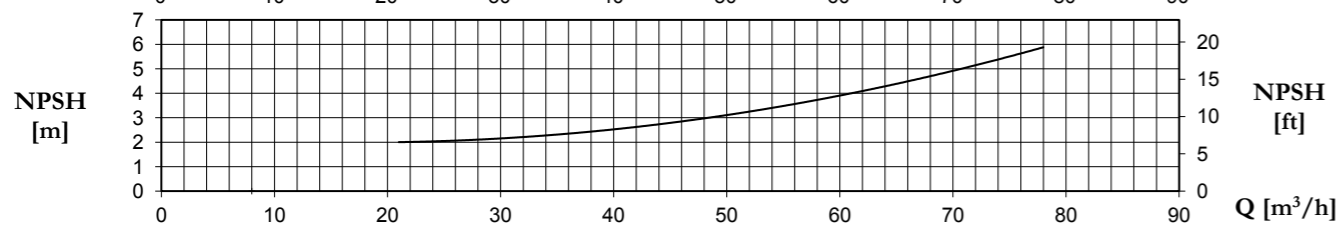
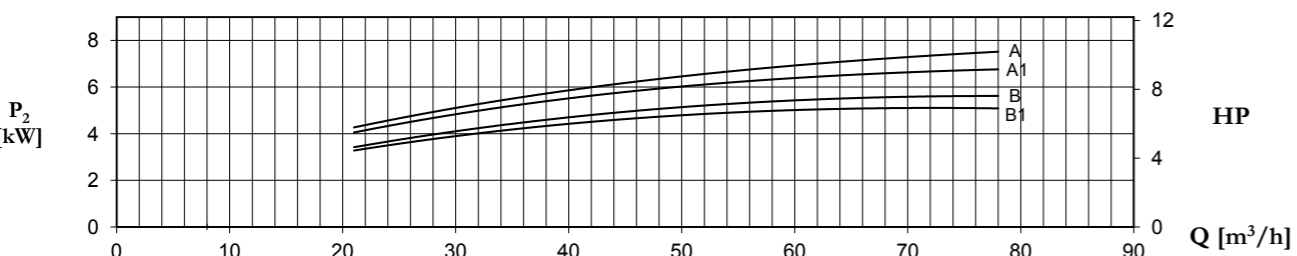
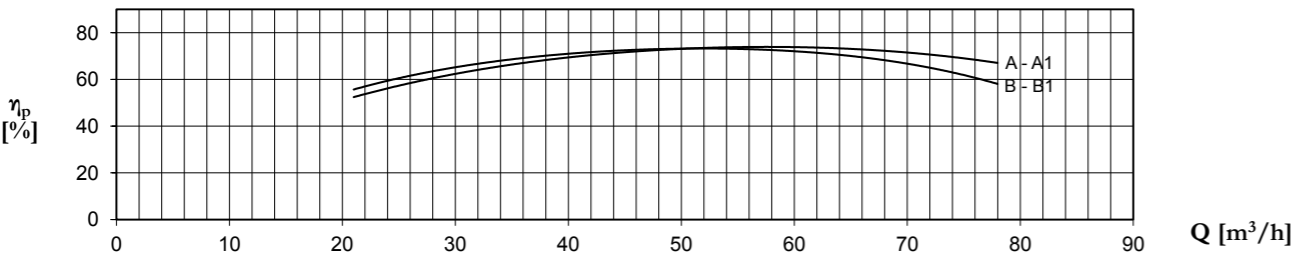
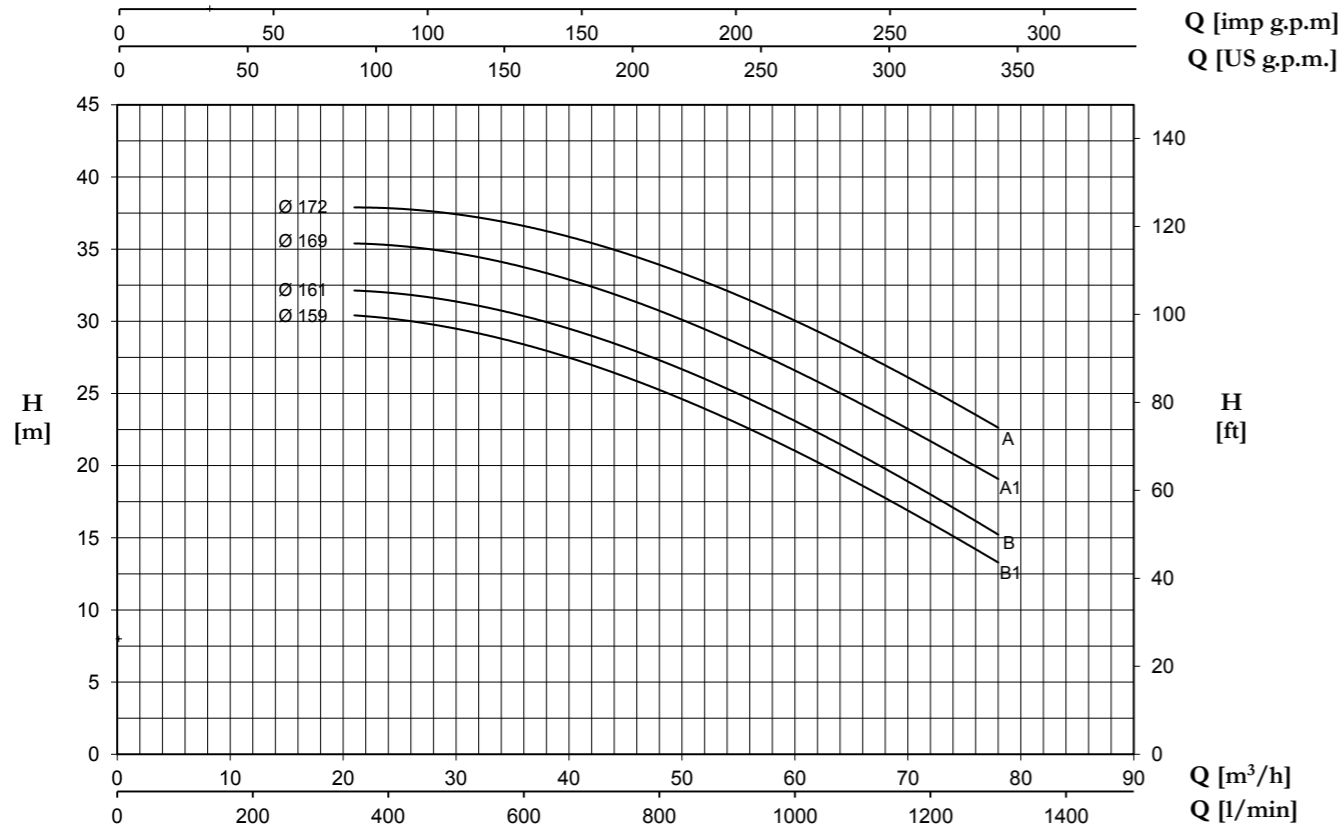

Tolerance: ISO 9906:2012 - Grade 3B

TYPE	P2		P1 (kW)	Q (m³/h - l/min)															
				A															
				3~															
3~	(HP)	(kW)	3~	0	21	24	27	30	33	36	39	42	48	54	60	66	72	78	
				0	350	400	450	500	550	600	650	700	800	900	1000	1100	1200	1300	
				3x400V 50 Hz															
				H (m)															
50-160 B1	7,5	5,5	6,2	10,7	29,3	30,3	30,2	30	29,6	29	28,4	27,7	26,9	25,2	23,2	21	18,7	16,1	13,2
50-160 B	7,5	5,5	6,7	11,6	31,1	32,1	32	31,7	31,4	31	30,4	29,7	28,9	27,3	25,3	23,1	20,7	18	15,2
50-160 A1	10	7,5	8,3	14,1	34,3	35,4	35,3	35	34,7	34,3	33,8	33,2	32,4	30,7	28,7	26,5	24,3	21,8	19
50-160 A	10	7,5	9,4	15,8	36,7	37,9	37,8	37,7	37,4	37,1	36,6	36,1	35,4	33,9	32,1	30	27,8	25,3	22,6

50-200

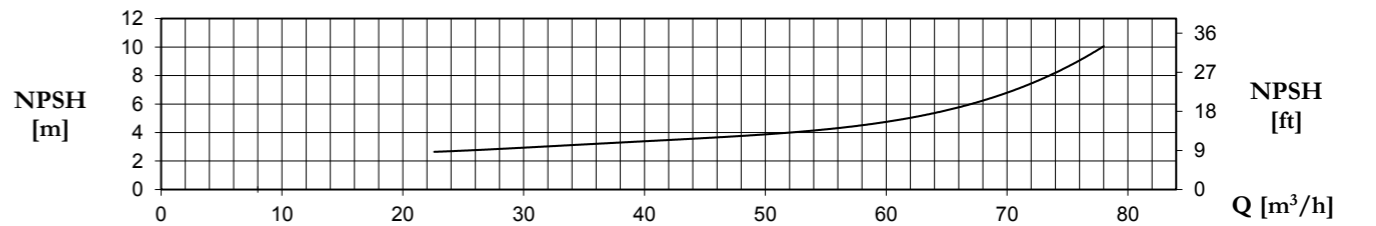
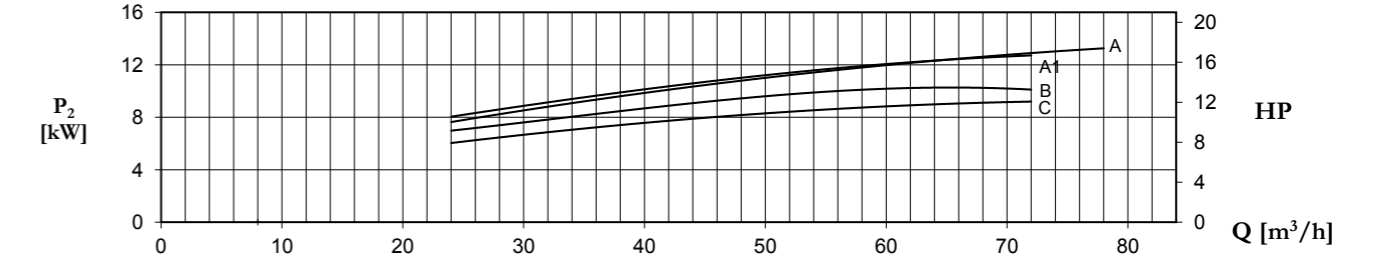
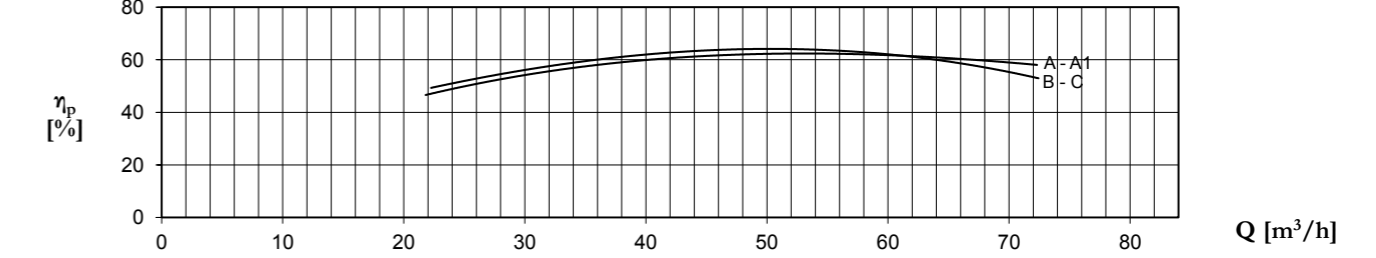
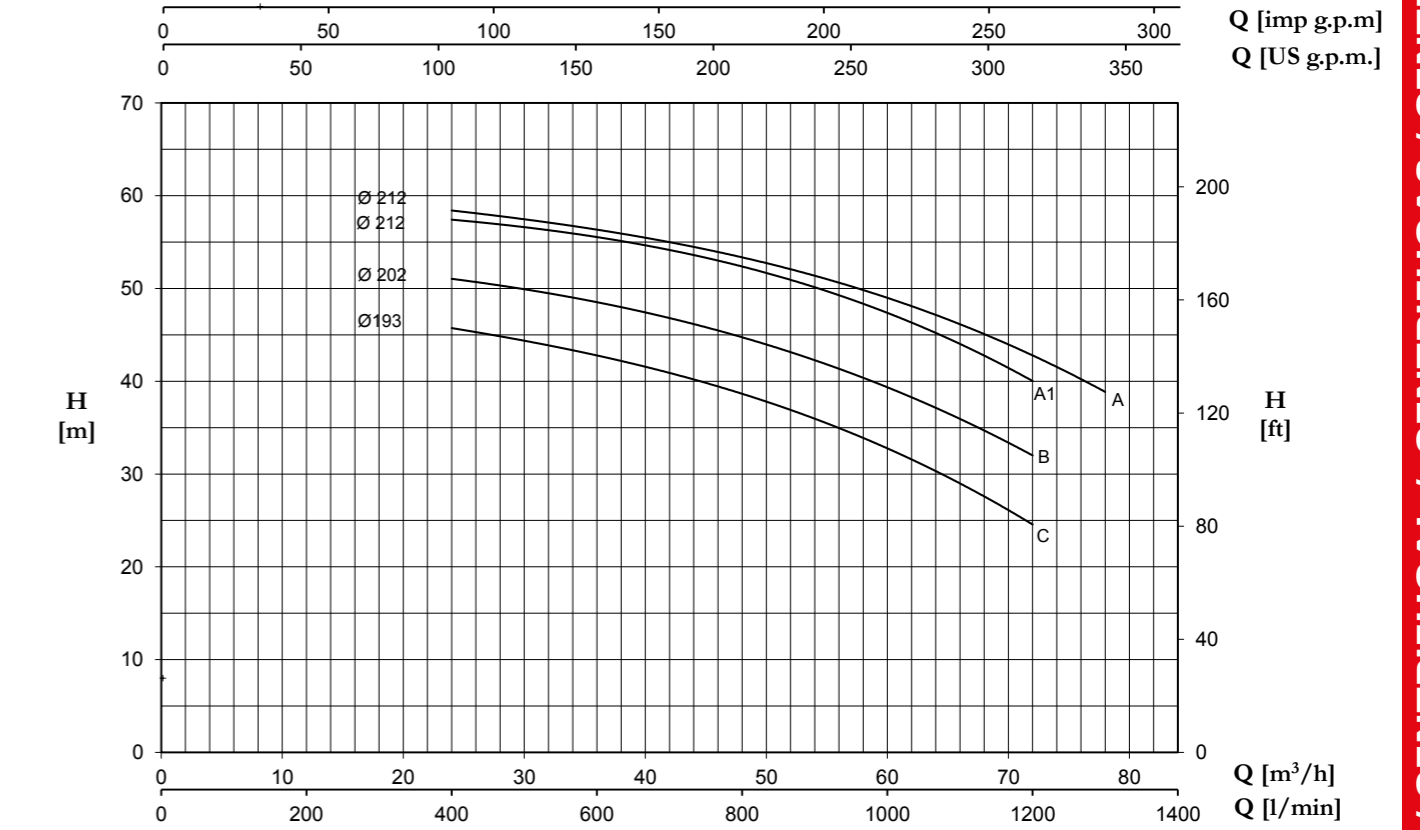

Tolerance: ISO 9906:2012 - Grade 3B

TYPE	P2		P1 (kW)	Q (m³/h - l/min)														
				A														
				3~														
3~	(HP)	(kW)	3~	0	24	27	30	33	36	39	42	48	54	60	66	72	78	
				0	400	450	500	550	600	650	700	800	900	1000	1100	1200	1300	
				3x400V 50 Hz														
				H (m)														
50-200 C	12,5	9,2	10,8	18,5	46	45,6	45,1	44,5	43,7	42,9	41,8	40,8	38,5	35,9	33	29	24,5	-
50-200 B	15	11	12,4	21,0	50,8	51	50,5	50	49,3	48,5	47,7	46,8	44,7	42,2	39,5	35,9	32	-
50-200 A1	20	15	14,5	25,4	57	57,3	57,1	56,7	56,2	55,6	54,8	54,1	52,2	50,2	47,5	44	40	-
50-200 A	20	15	15,4	27,0	58	58,3	58	57,5	57	56,4	55,7	55	53,2	51,3	49	46,3	42,8	38,8

50-250

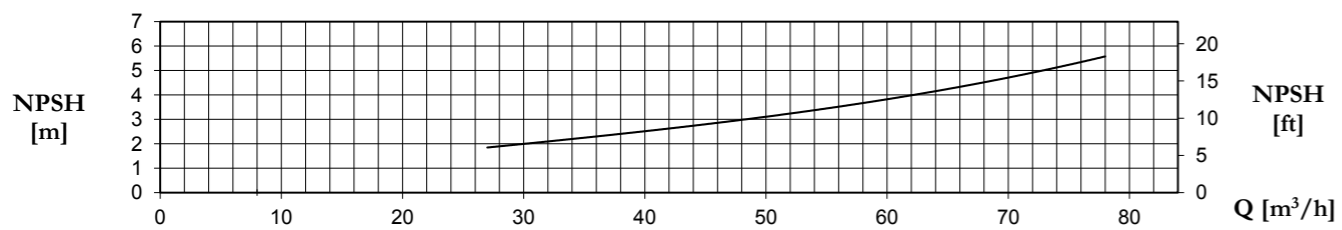
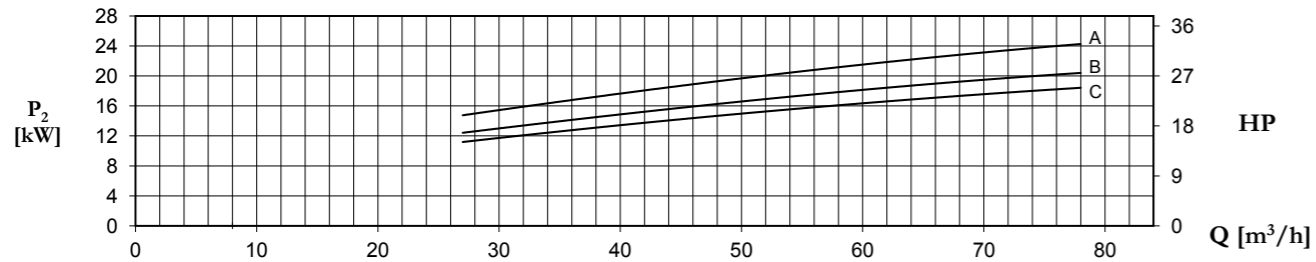
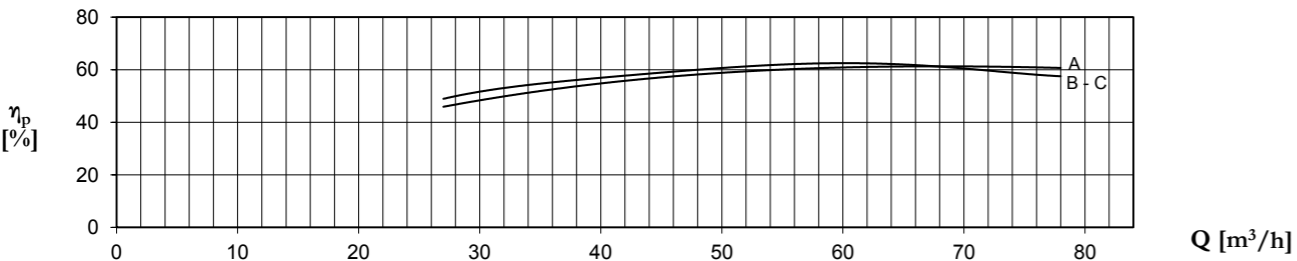
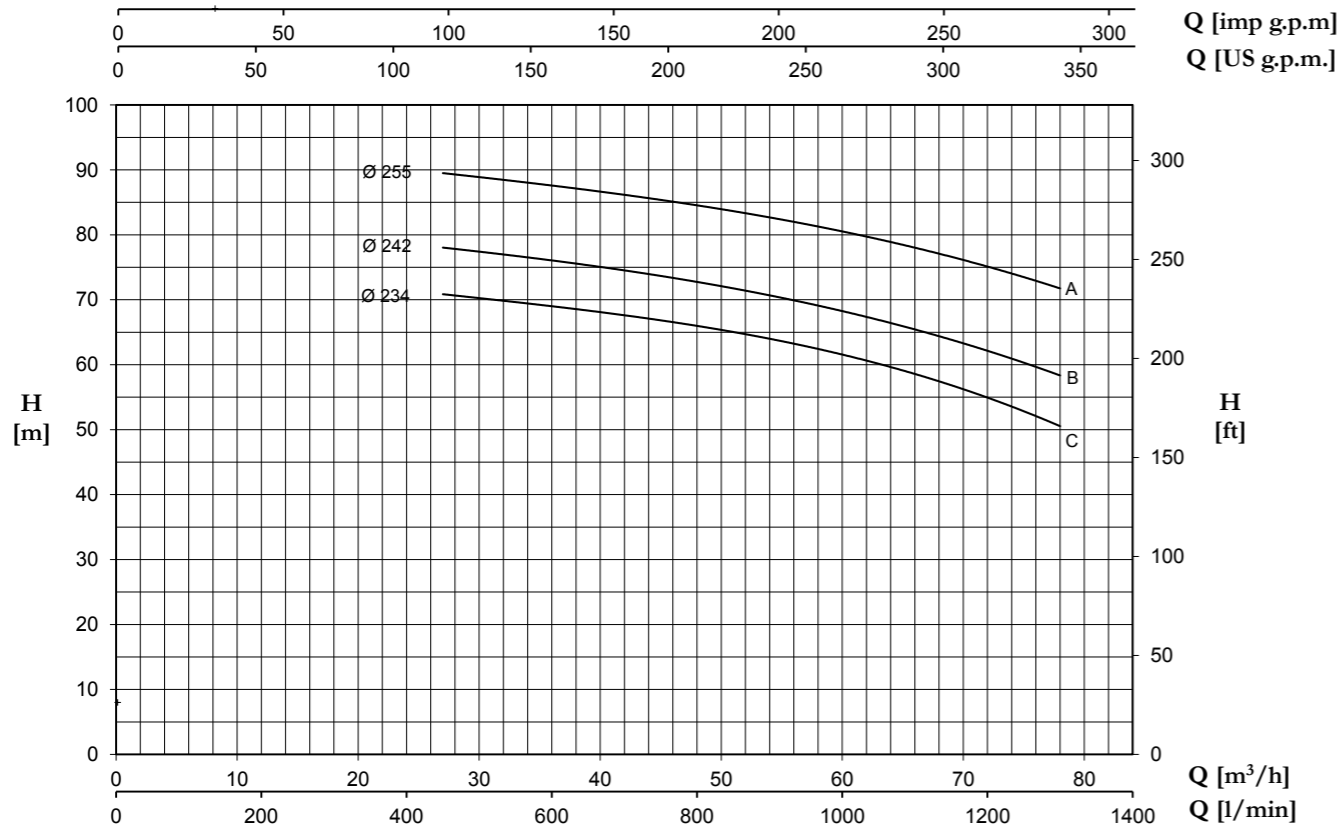

Tolerance: ISO 9906:2012 - Grade 3B

TYPE	P2		P1 (kW)	Q (m³/h - l/min)													
				3~													
				0	27	30	33	36	39	42	48	54	60	66	72	78	
3~	(HP)	(kW)	3~	H (m)													
				3x400 V 50 Hz	71,5	70,8	70,3	69,7	69	68,3	67,6	66	64	61,5	58,6	55	50,5
50-250 C	20	15	20	41,5	78,0	78	77,4	76,8	76,1	75,3	74,5	72,8	70,6	68,2	65,5	62,2	58,3
50-250 B	25	18,5	23	51,5	90	89,5	88,8	88,3	87,7	86,9	86,1	84,5	82,7	80,5	78	75,2	71,7

65-125

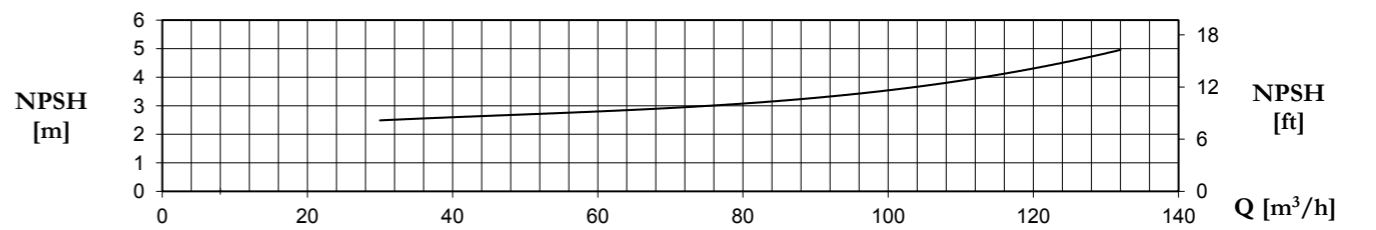
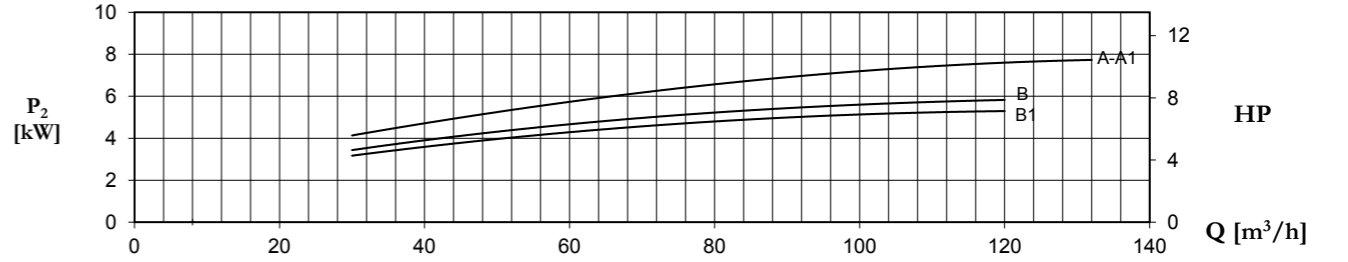
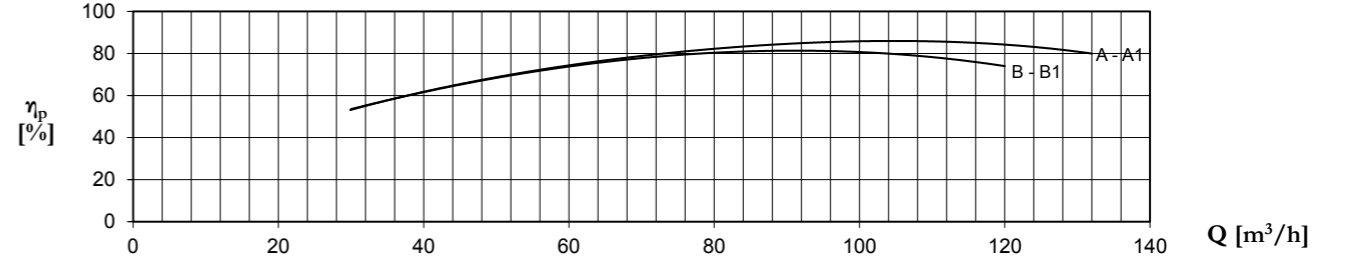
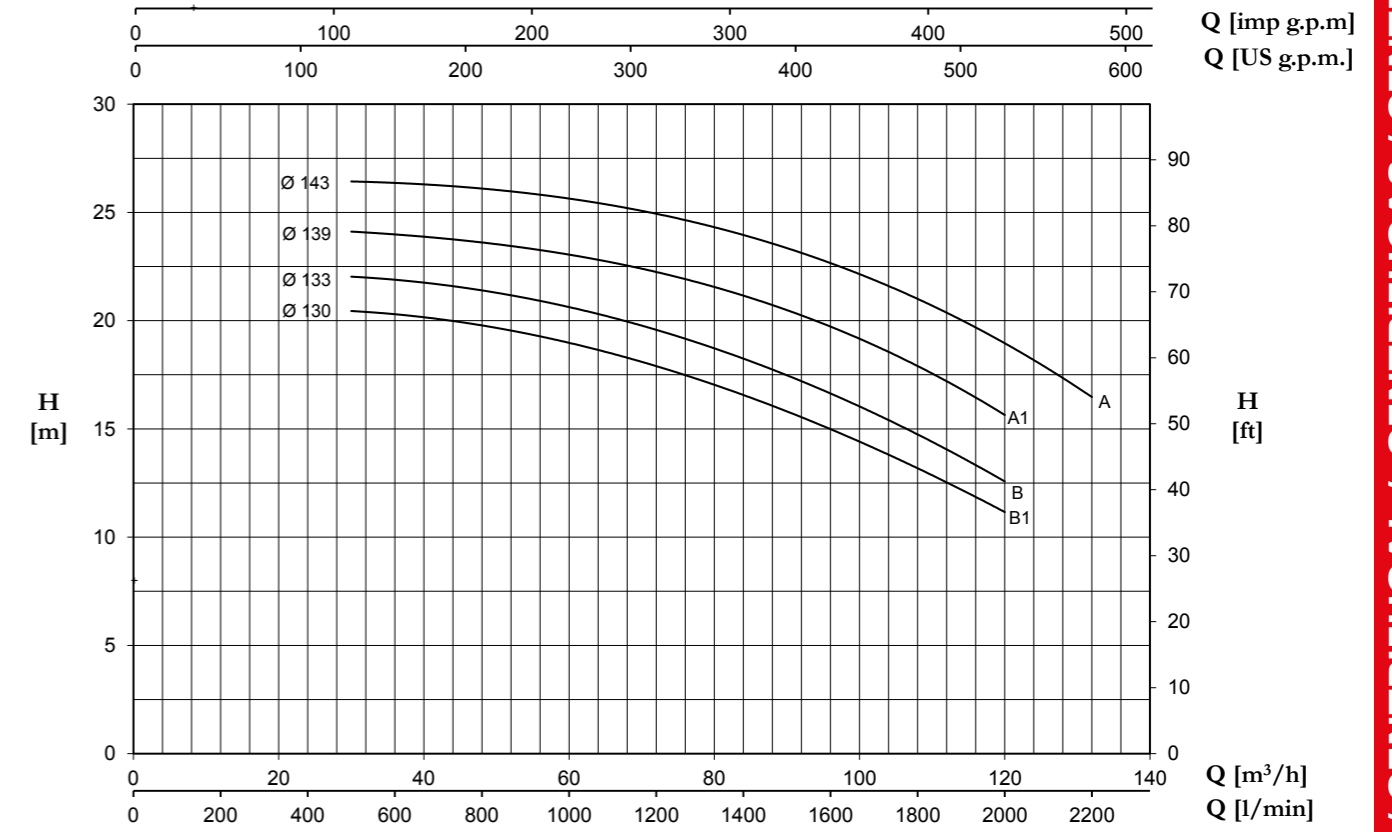

Tolerance: ISO 9906:2012 - Grade 3B

TYPE	P2		P1 (kW)	Q (m³/h - l/min)																	
				3~																	
				0	30	33	36	39	42	48	54	60	66	72	78	84	96	108	120	132	
3~	(HP)	(kW)	3~	H (m)																	
				3x400 V 50 Hz	11	19,4	20,4	20,4	20,3	20,2	20,1	19,8	19,4	19	18,5	17,9	17,2	16,5	15	13,3	11,1
65-125 B1	7,5	5,5	6,4	12,6	20,9	22	22	21,9	21,8	21,7	21,4	21	20,6	20,1	19,6	19	18,3	16,6	14,7	12,6	-
65-125 B	10	7,5	8,1	14	23	24,1	24,1	24	23,9	23,8	23,6	23,3	23	22,7	22,3	21,8	21,2	19,7	17,8	15,7	-
65-125 A1	10	7,5	9,5	16,3	25,4	26,4	26,4	26,4	26,3	26,3	26,1	25,9	25,6	25,3	24,9	24,5	24	22,7	21	18,9	16,5

65-160

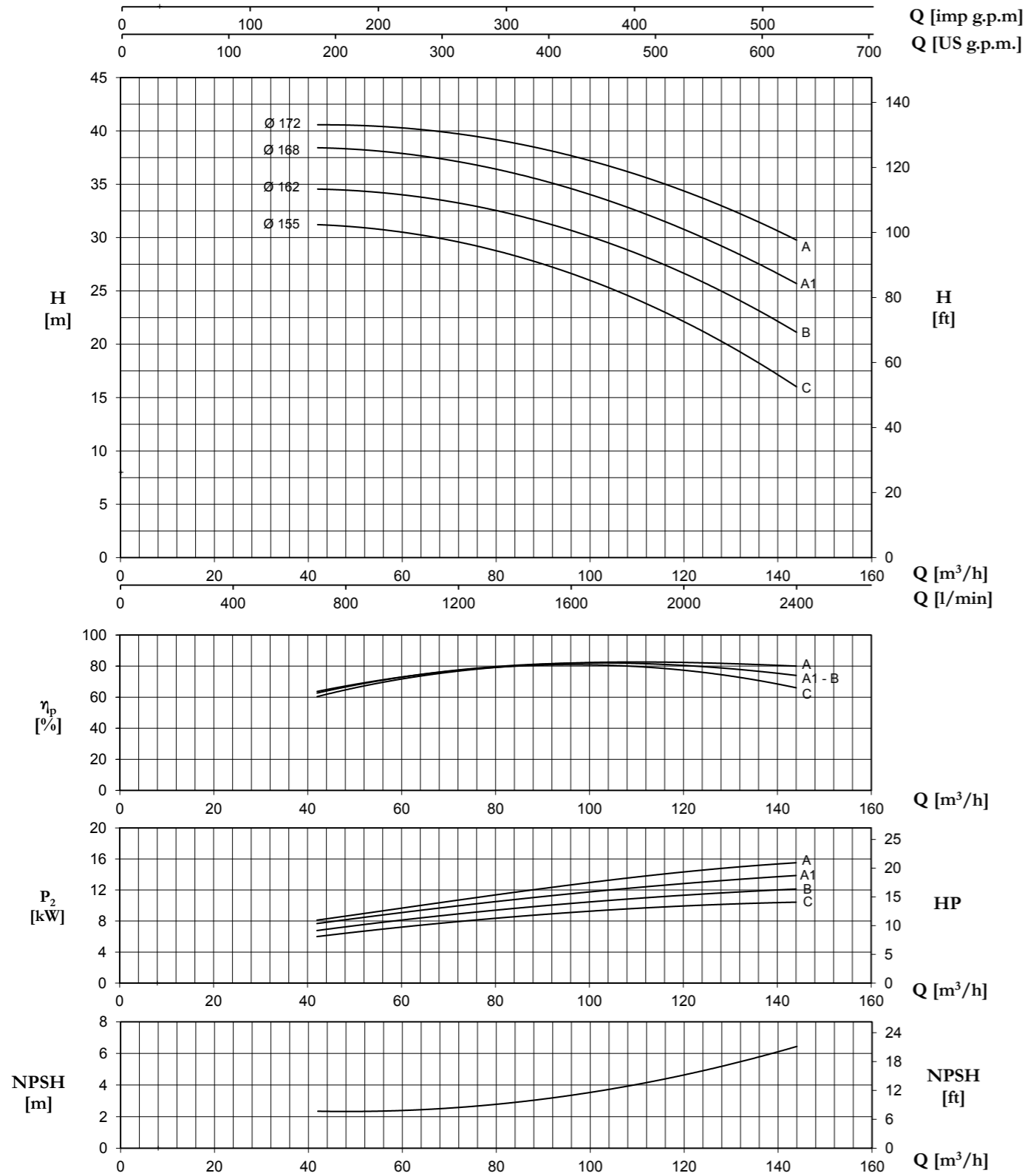

Tolerance: ISO 9906:2012 - Grade 3B

TYPE	P ₂		P ₁ (kW)	Q (m³/h - l/min)											
				A	Q (m³/h - l/min)										
					3~	0	42	48	60	72	78	84	108	132	144
3~			3~	0	700	800	1000	1200	1300	1400	1800	2200	2400		
			3x400 V 50 Hz	H (m)											
65-160 C	12,5	9,2	11,7	19,5	29,8	31,2	31,1	30,5	29,6	29	28,3	24,6	19,3	16	
65-160 B	15	11	13	22,5	33	34,6	34,4	34	33,3	32,8	32,1	28,8	24,1	21,1	
65-160 A1	20	15	15,8	27,6	37,1	38,5	38,3	37,8	37,1	36,7	36,1	32,8	28,4	25,7	
65-160 A	20	15	18	30,0	39,2	40,6	40,6	40,2	39,7	39,4	38,9	36,2	32,2	29,8	

65-200

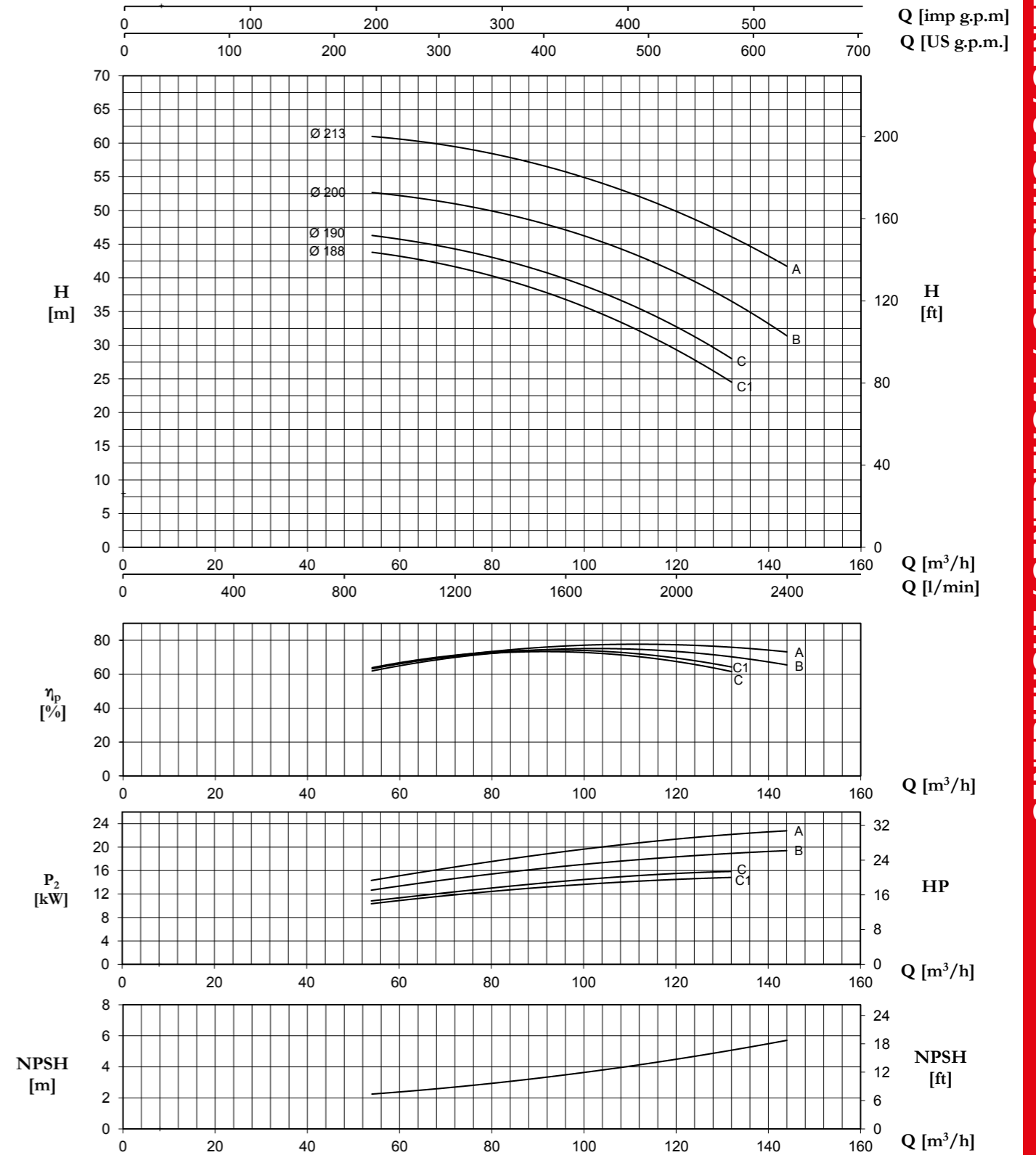

Tolerance: ISO 9906:2012 - Grade 3B

TYPE	P ₂		P ₁ (kW)	Q (m³/h - l/min)															
				A	Q (m³/h - l/min)														
					3~	0	54	60	66	72	78	84	96	108	120	132	144		
3~			3~	0	900	1000	1100	1200	1300	1400	1600	1800	2000	2200	2400				
			3x400 V 50 Hz	H (m)															
65-200 C1	20	15	17,1	28,8	43,1	43,8	43,2	42,5	41,7	40,6	39,5	36,8	33,4	29,3	24,5	-			
65-200 C	20	15	18,6	31,4	45,3	46,3	45,7	45,1	44,3	43,4	42,3	39,8	36,7	32,7	28,0	-			
65-200 B	25	18,5	22,6	38,2	51,6	52,6	52,2	51,8	51,0	50,2	49,3	47,1	44,1	40,9	36,6	31,3			
65-200 A	30	22	26,6	43,8	60,2	61,0	60,6	60,1	59,5	58,7	57,8	55,8	53,1	49,8	46,1	41,7			

65-250

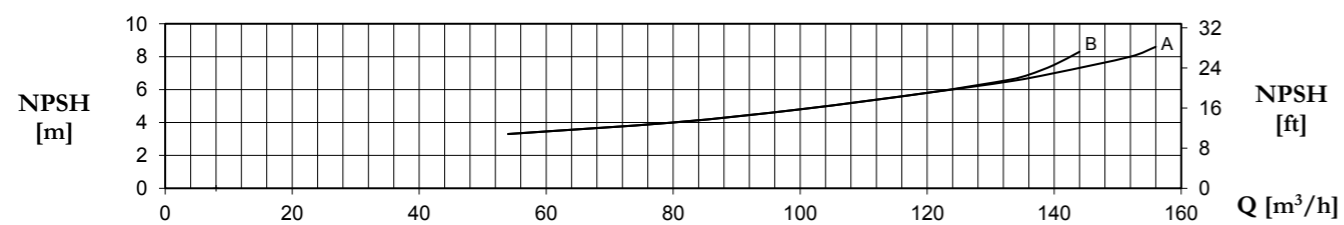
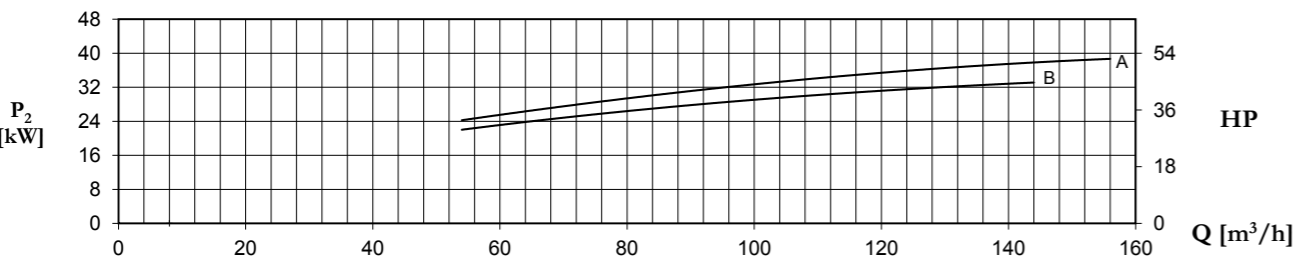
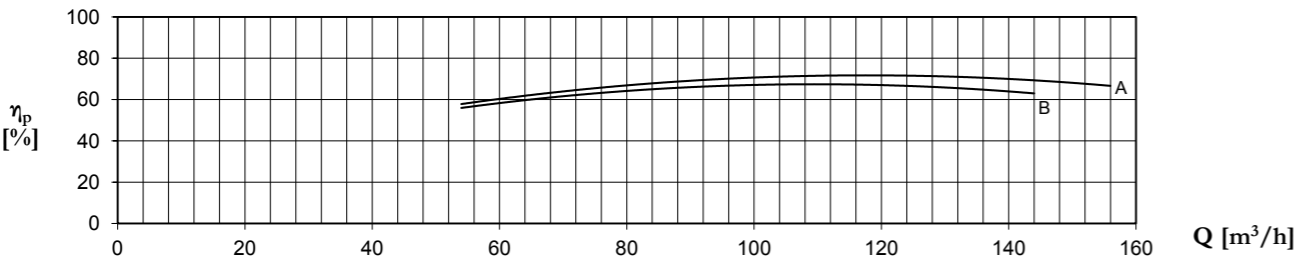
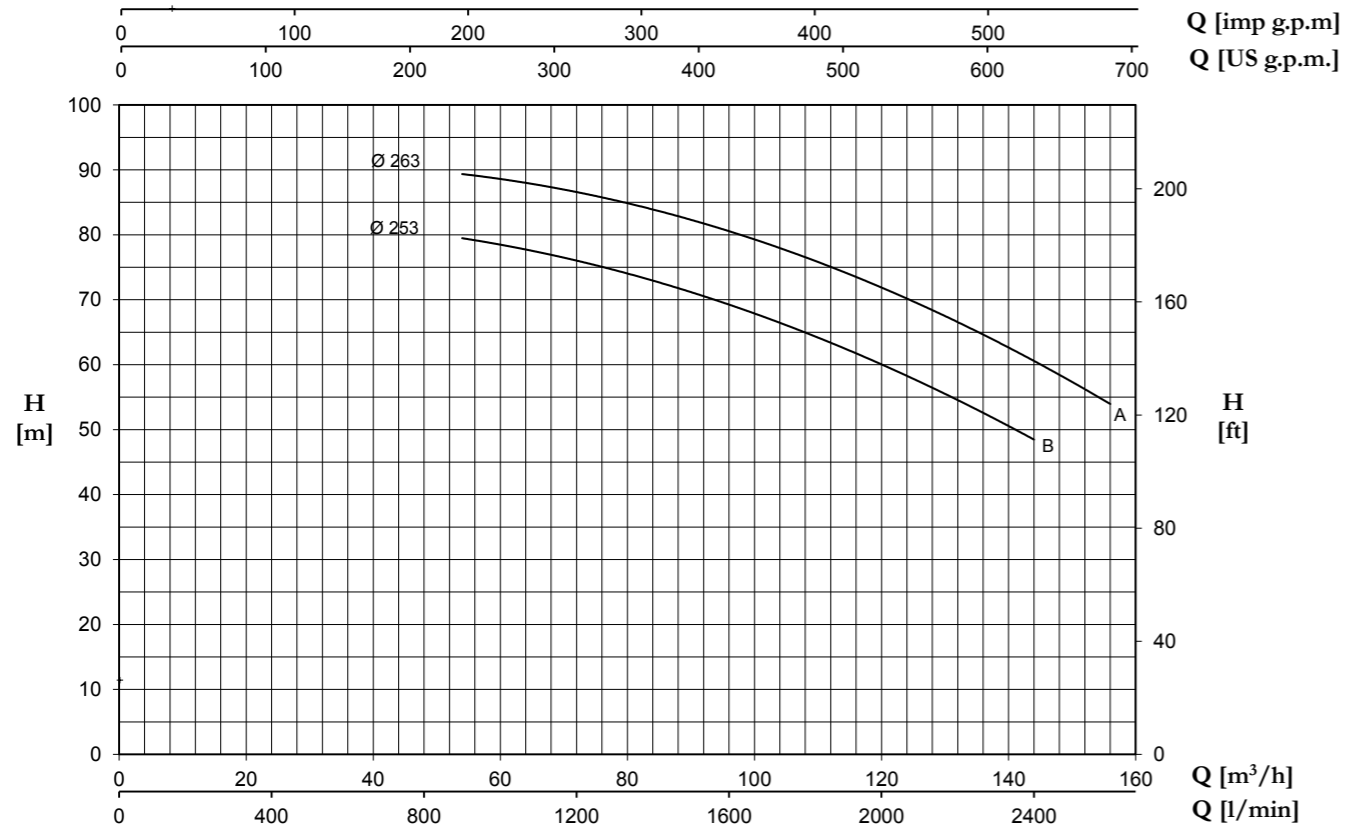

Tolerance: ISO 9906:2012 - Grade 3B

TYPE	P2		P1 (kW)	Q (m³/h - l/min)														
				3~	H (m)													
					0	54	60	66	72	78	84	96	108	120	132	144	156	
3~	(HP)	(kW)	3~	0	900	1000	1100	1200	1300	1400	1600	1800	2000	2200	2400	2600		
				3x400 V 50 Hz														
65-250 B	40	30	37,8	63,5	81,0	79,5	78,5	77,3	76,0	74,5	73,0	69,3	65,0	60,0	54,5	48,5	-	
65-250 A	50	37	45	74,5	90,0	89,5	88,5	87,5	86,5	85,5	84,0	80,5	76,5	72,0	66,5	60,5	54,0	

80-160

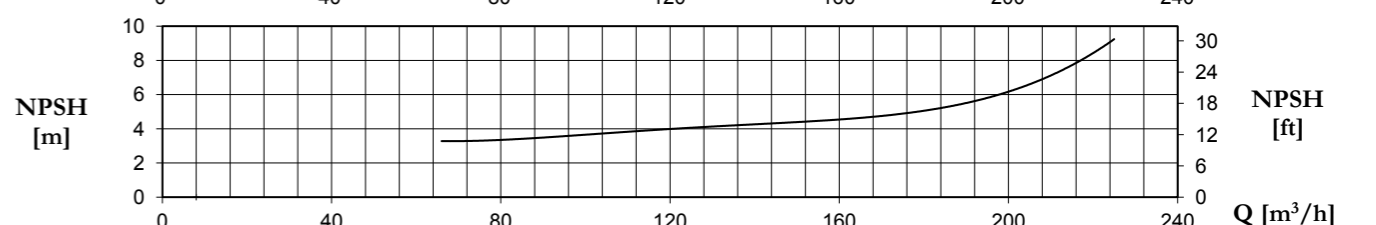
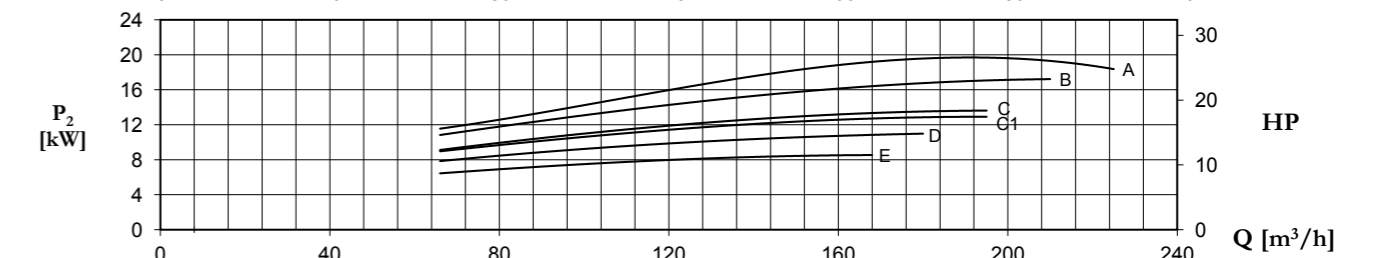
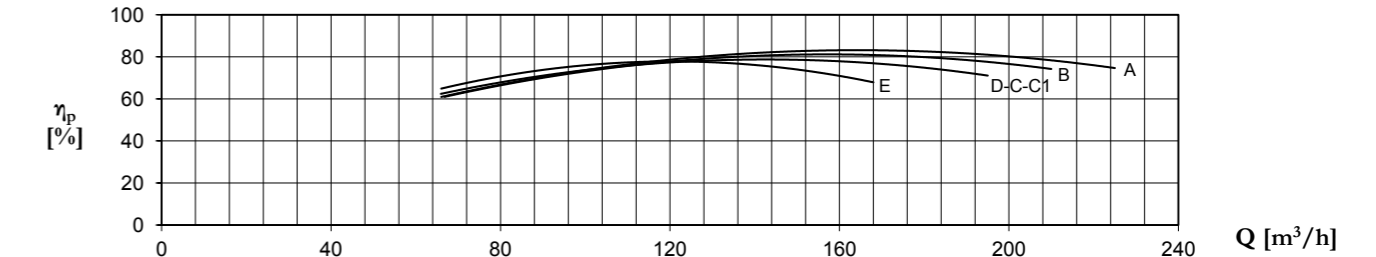
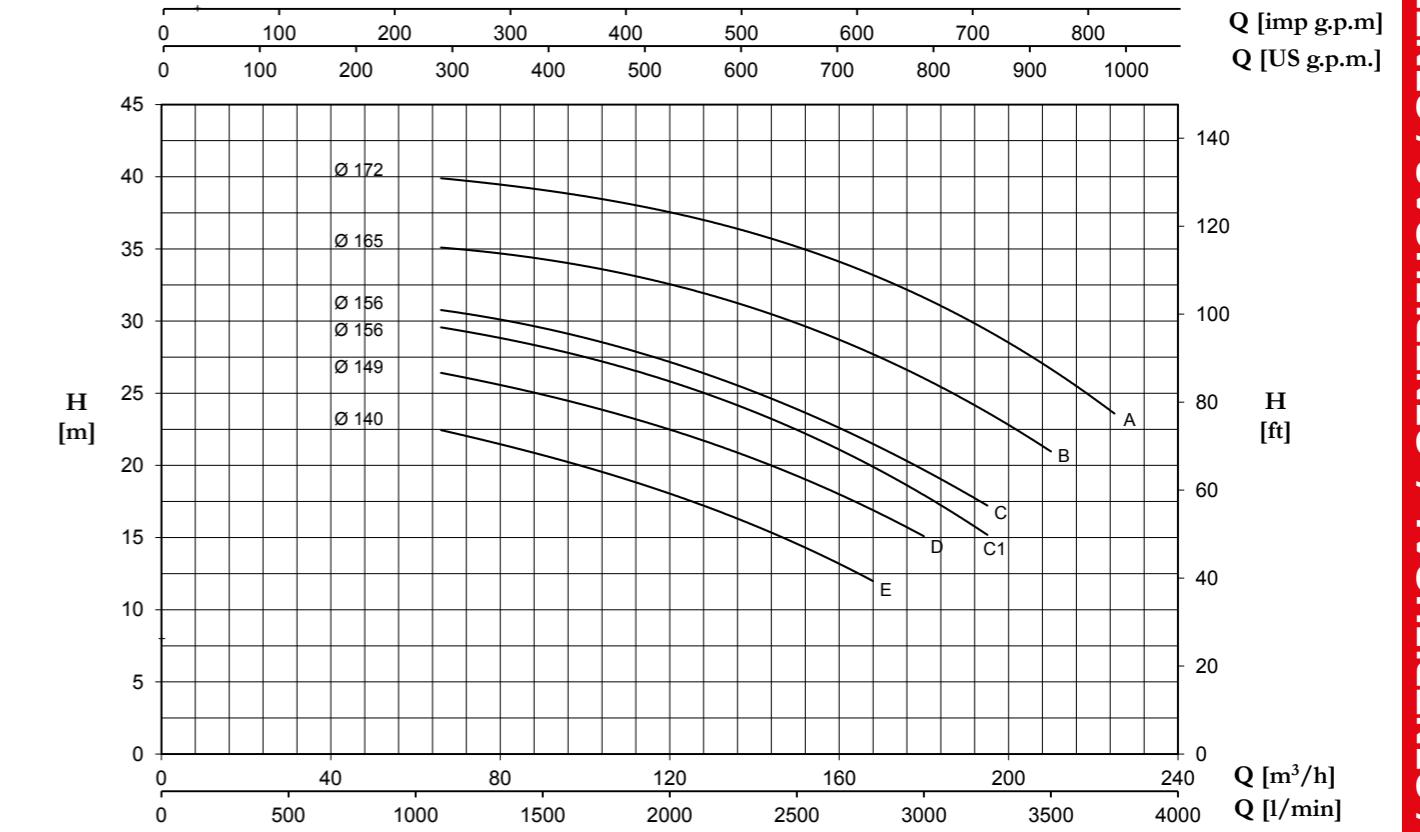

Tolerance: ISO 9906:2012 - Grade 3B

TYPE	P2		P1 (kW)	Q (m³/h - l/min)																							
				3~	H (m)																						
					0	66	72	78	84	96	108	120	132	144	156	168	180	195	210	225							
3~	(HP)	(kW)	3~	0	1100	1200	1300	1400	1600	1800	2000	2200	2400	2600	2800	3000	3250	3500	3750								
				3x400 V 50 Hz																							
80-160 E	12,5	9,2	9,9	17,2	21,4	22,4	22,1	21,6	21,2	20,2	19,2	18	16,8	15,4	13,7	12	-	-	-	-							
80-160 D	15	11	12,7	22,1	25,4	26,4	26,1	25,7	25,3	24,4	23,6	22,5	21,3	20	18,5	16,9	15,1	-	-	-	-						
80-160 C1	20	15	14,8	25,5	28,5	29,5	29,3	29	28,6	27,8	26,9	25,7	24,6	23,3	21,7	19,9	17,9	15,2	-	-	-						
80-160 C	20	15	15,9	27,4	29,7	30,7	30,5	30,3	29,9	29,2	28,1	27,1	26	24,7	23,1	21,5	19,7	17,2	-	-	-						
80-160 B	25	18,5	20,1	34,8	34	35	35	34,8	34,6	34	33,3	32,5	31,6	30,5	29,2	27,8	26	23,6	21	-	-						
80-160 A	30	22	23,7	39,8	38,8	39,8	39,7	39,6	39,4	38,9	38,2	37,5	36,7	35,7	34,5	33,2	31,6	29,4	26,8	23,5	-						

80-200

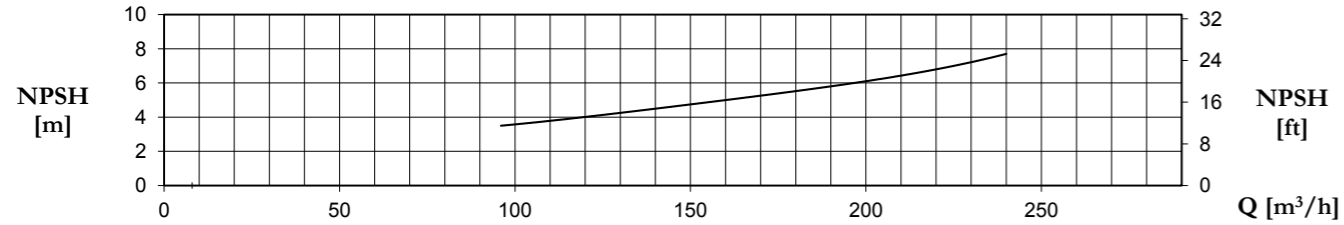
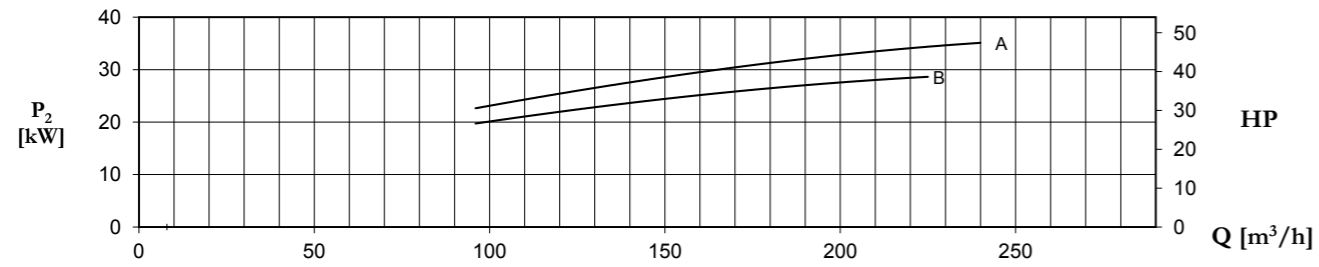
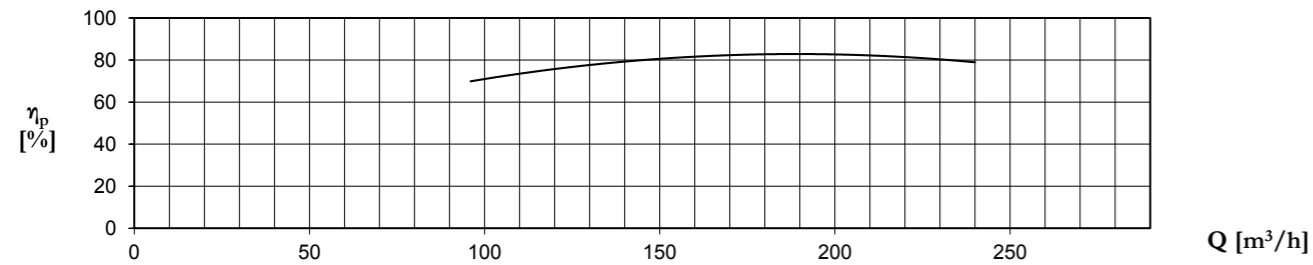
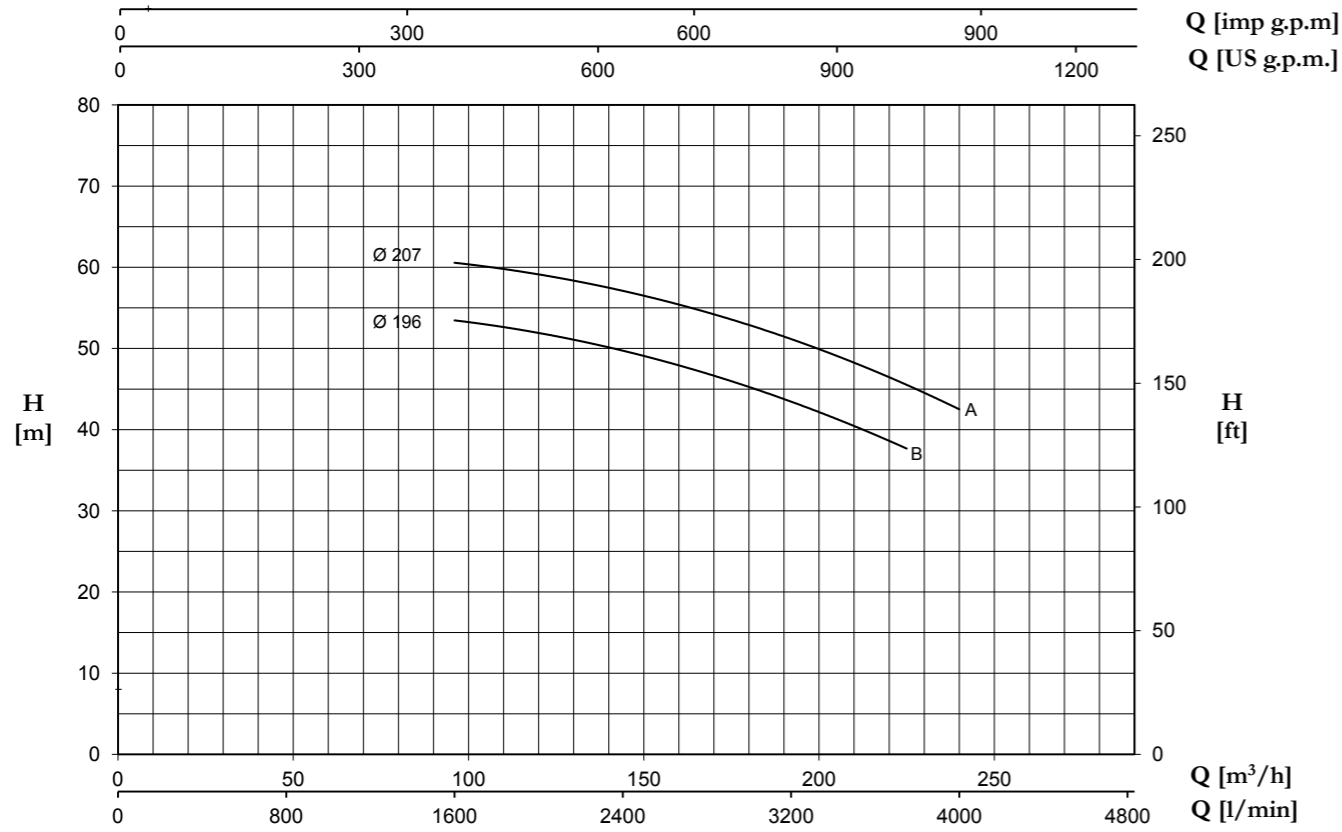

Tolerance: ISO 9906:2012 - Grade 3B

TYPE	P2		P1 (kW)	Q (m³/h - l/min)												
				A	Q (m³/h - l/min)											
					3~	0	96	120	132	156	168	180	210	225	240	
3~	(HP)	(kW)	3~	3x400 V 50 Hz	H (m)											
80-200 B	40	30	33,8	56,5	50,1	53,5	51,8	50,9	48,5	46,9	45,2	40,4	37,7	-		
80-200 A	50	37	40,5	67,0	56,7	60,6	59,1	58,1	56,0	54,4	52,7	48,3	45,6	42,4		

100-160

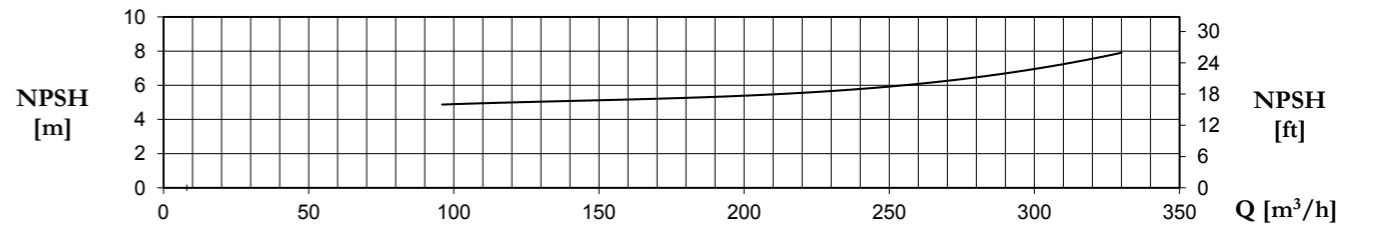
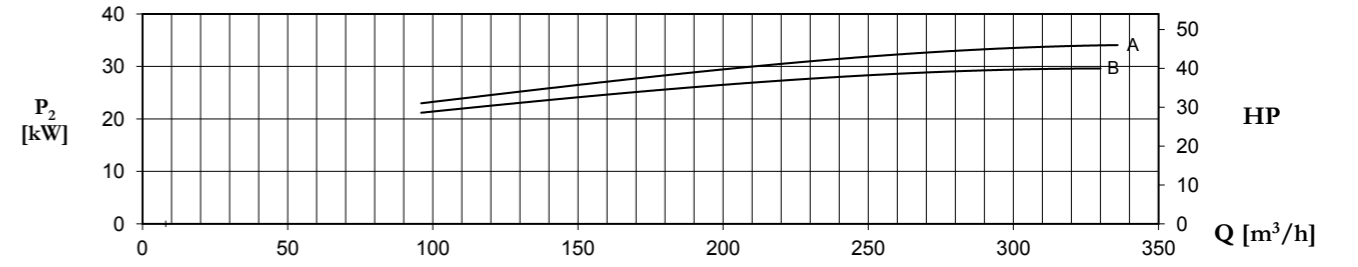
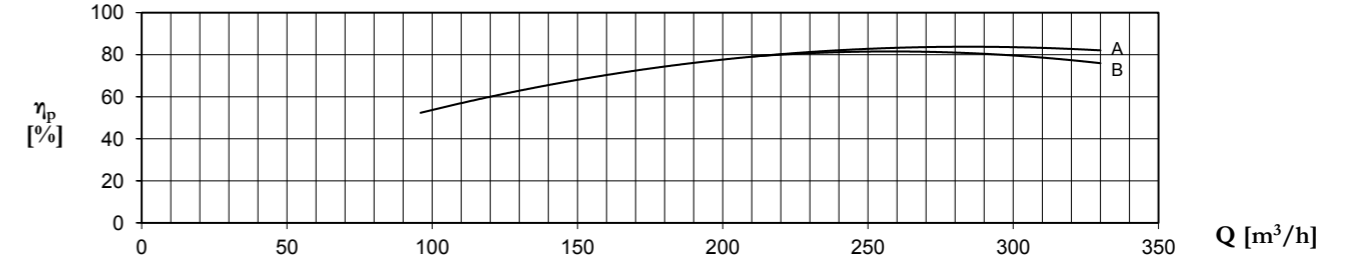
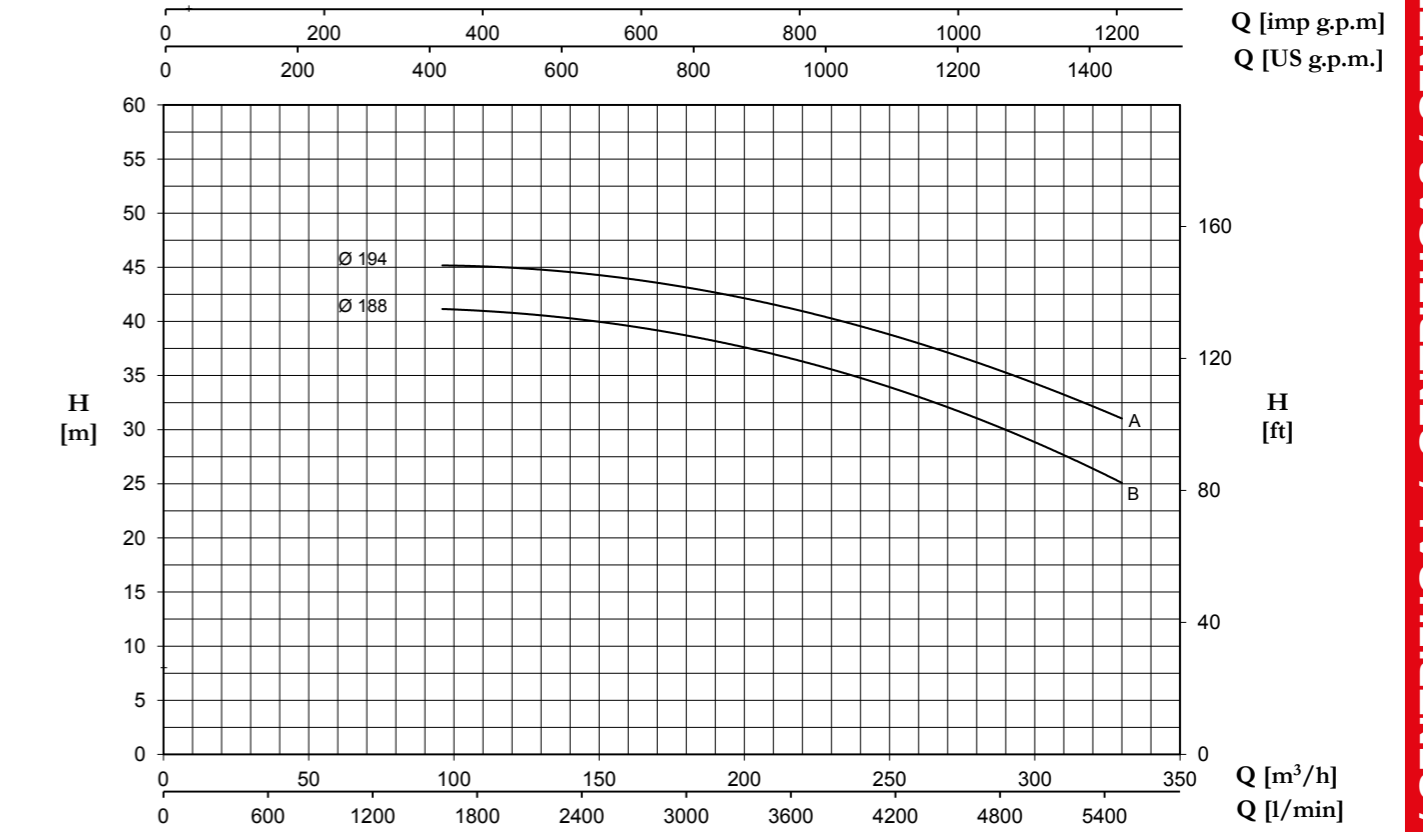

Tolerance: ISO 9906:2012 - Grade 3B

TYPE	P2		P1 (kW)	Q (m³/h - l/min)																		
				A	Q (m³/h - l/min)																	
					3~	0	96	108	120	132	144	156	168	180	195	210	225	240	270	300	330	
3~	(HP)	(kW)	3~	3x400 V 50 Hz	H (m)																	
100-160 B	40	30	35	57,2	41,8	41,1	41,1	40,9	40,6	40,2	39,7	39,2	38,6	37,9	37,0	36,0	34,8	32,1	28,8	25,1		
100-160 A	50	37	39	65	45,7	45,1	45,2	45,1	44,8	44,4	44,0	43,6	43,2	42,4	41,5	40,5	39,5	37,2	34,3	31,0		

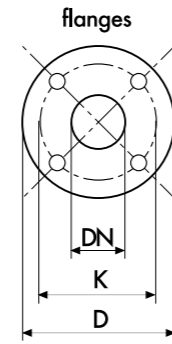
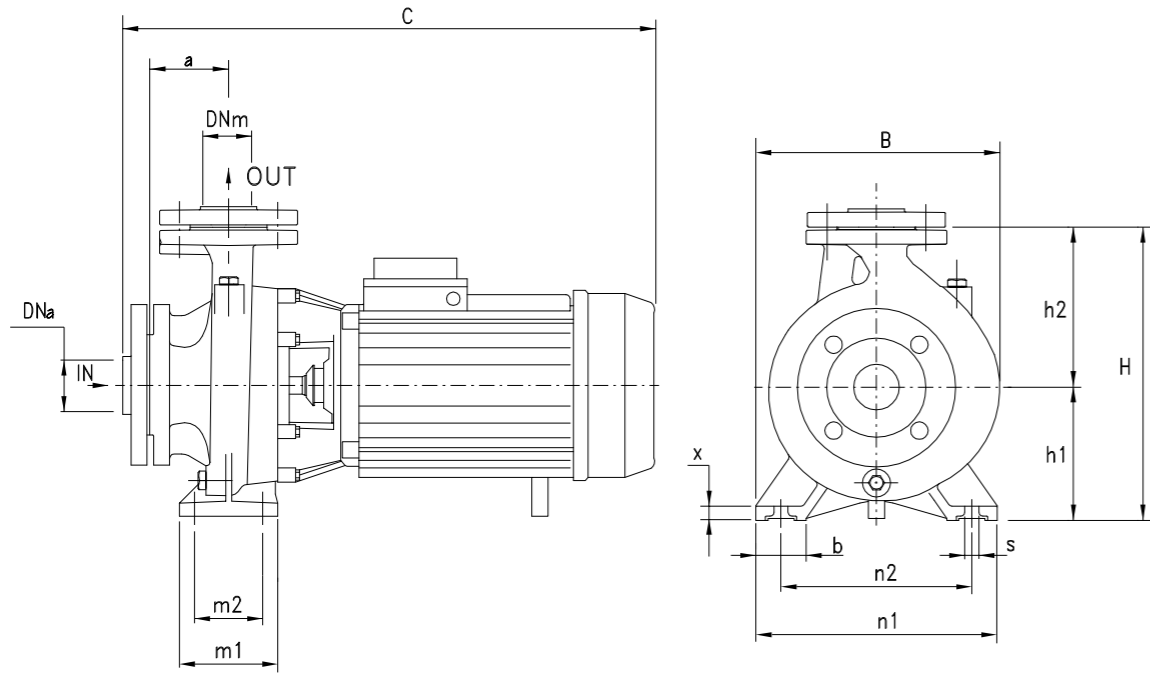

DIMENSIONS (mm)				
DN	D	K	holes	
			n°	Ø
32	140	100	4	18
40	150	110	4	18
50	165	125	4	18
65	185	145	4	18
80	200	160	8	18
100	220	180	8	18
125	250	210	8	18

TYPE	TRUCK		CONTAINER	
	PALLET (cm)	N° pumps	PALLET (cm)	N° pumps
32-160	80X120X155	24	80X120X190	30
32-200 C		24	80X120X180	24
32-200 A/B	100X120X140	18	100X120X185	24
32-250 A	85X110X120	6	85X110X170	9
32-250 B/C	80X120X120	6	80X120X170	9
40-125	80X120X155	24	80X120X190	30
40-160	80X120X155	24	80X120X190	30
40-200	100X120X140	18	100X120X185	24
40-250 A	85X110X120	6	85X110X170	9
40-250 B/C	80X120X120	6	80X120X170	9
50-125	80X120X120	24	80X120X180	24
50-160		18	100X120X185	24
50-200 A	85X110X120	6	85X110X170	9
50-200 B/C	80X120X120	6	80X120X170	9
50-250	80X120X120	6	80X120X170	9
65-125	100X120X140	18	100X120X185	24
65-160	85X110X120	6	85X110X170	9
65-200	85X110X120	6	85X110X170	9
65-250	85X110X130	4	85X110X190	6
80-160	85X110X120	6	85X110X170	9
80-200	85X110X130	4	85X110X190	6

TYPE	DIMENSIONS (mm)																		Kg
	DNa	DNm	a	h1	h2	m1	m2	n1	n2	b	x	s	C	B	H	I	L	M	
32-160 C	50	32	80	132	160	100	70	240	190	50	12	14	490	240	292	520	260	355	38
32-160 B	50	32	80	132	160	100	70	240	190	50	12	14	490	240	292	520	260	355	39
32-160 A	50	32	80	132	160	100	70	240	190	50	12	14	490	240	292	520	260	355	42
32-200 C	50	32	80	160	180	100	70	240	190	50	12	14	505	268	340	530	305	400	51.5
32-200 B1	50	32	80	160	180	100	70	240	190	50	12	14	520	268	340	615	310	460	61
32-200 B	50	32	80	160	180	100	70	240	190	50	12	14	565	268	340	615	310	460	63
32-200 A1	50	32	80	160	180	100	70	240	190	50	12	14	520	268	340	615	310	460	67
32-200 A	50	32	80	160	180	100	70	240	190	50	12	14	565	268	340	615	310	460	69
32-250 C	50	32	100	180	225	125	95	320	250	65	12	14	625	305	405	665	335	535	83
32-250 B	50	32	100	180	225	125	95	320	250	65	14	14	625	305	405	665	335	535	90
32-250 A1	50	32	100	180	225	125	95	320	250	65	14	14	625	305	405	665	335	535	95
32-250 A	50	32	100	180	225	125	95	320	250	65	14	14	695	305	405	735	355	535	120
40-125 C	65	40	80	112	140	100	70	210	160	50	12	14	495	220	252	520	260	355	36
40-125 B	65	40	80	112	140	100	70	210	160	50	12	14	495	220	252	520	260	355	37
40-125 A	65	40	80	112	140	100	70	210	160	50	12	14	495	220	252	520	260	355	40
40-160 B	65	40	80	132	160	100	70	240	190	50	12	14	500	245	292	520	260	355	47
40-160 A	65	40	80	132	160	100	70	240	190	50	15	14	500	245	292	520	260	355	50
40-200 B1	65	40	100	160	180	100	70	240	190	50	15	14	545	273	340	615	310	460	63
40-200 B	65	40	100	160	180	100	70	265	212	50	15	14	590	273	340	615	310	460	65
40-200 A1	65	40	100	160	180	100	70	240	190	50	15	14	545	273	340	615	310	460	69
40-200 A	65	40	100	160	180	100	70	265	212	50	15	14	590	273	340	615	310	460	71
40-250 C	65	40	100	180	225	125	95	320	250	65	15	14	630	322	405	665	335	535	84
40-250 B	65	40	100	180	225	125	95	320	250	65	15	14	630	322	405	665	335	535	91
40-250 A1	65	40	100	180	225	125	95	320	250	65	15	14	630	322	405	665	335	535	96
40-250 A	65	40	100	180	225	125	95	320	250	65	15	14	700	322	405	735	355	535	121
40-250 BM	65	40	100	180	225	125	95	320	250	65	14	14	750	332	405	815	355	535	140
40-250 AM	65	40	100	180	225	125	95	320	250	65	14	14	750	332	405	815	355	535	149
50-125 B	65	50	100	132	160	100	70	240	190	50	12	14	525	250	292	520	260	355	47
50-125 A	65	50	100	132	160	100	70	240	190	50	12	14	525	250	292	520	260	355	50
50-160 B1	65	50	100	160	180	100	70	265	212	50	12	14	545	270	340	615	310	460	63
50-160 B	65	50	100	160	180	100	70	265	212	50	12	14	590	270	340	615	310	460	65
50-160 A1	65	50	100	160	180	100	70	265	212	50	12	14	545	270	340	615	310	460	69
50-160 A	65	50	100	160	180	100	70	265	212	50	12	14	590	270	340	615	310	460	71
50-200 C	65	50	100	160	200	100	70	265	212	50	12	14	635	290	360	665	335	535	82
50-200 B	65	50	100	160	200	100	70	265	212	50	12	14	635	290	360	665	335	535	89
50-200 A1	65	50	100	160	200	100	70	265	212	50	12	14	635	290	360	665	335	535	94
50-200 A	65	50	100	160	200	100	70	265	212	50	12	14	705	290	360	735	355	535	122
50-250 C	65	50	100	180	225	125	95	320	250	65	14	14	705	332	405	735	355	535	125
50-250 B	65	50	100	180	225	125	95	320	250	65	14	14	750	332	405	815	355	535	140
50-250 A	65	50	100	180	225	125	95	320	250	65	14	14	750	332	405	815	355	535	149
65-125 B1	80	65	100	160	180	125	95	280	212	65	14	14	560	280	340	615	310	460	62
65-125 B	80	65	100	160	180	125	95	280	212	65	14	14	605	280	340	615	310	460	64
65-125 A1	80	65	100	160	180	125	95	280	212	65	14	14	560	280	340	615	310	460	68
65-125 A	80	65	100	160	180	125	95	280	212	65	14	14	605	280	340	615	310	460	70
65-160 C	80	65	100	160	200	125	95	280	212	65	14	14	635	290	360	665	335	535	84
65-160 B	80	65	100	160	200	125	95	280	212	65	14	14	635	290	360	665	335	535	90
65-160 A1	80	65	100	160	200	125	95	280	212	65	14	14	635	290	360	665	335	535	95
65-160 A	80	65	100	160	200	125	95	280	212	65	14	14	705	290	360	735	355	535	120
65-200 C1	80	65	100	180	225	125	95	320	250	65	14	14	675	330	405	735	355	535	92
65-200 C	80	65	100	180	225	125	95	320	250	65	14	14	705	330	405	735	355	535	122
65-200 B	80	65	100	180	225	125	95	320	250	65	14	14	750	330	405	815	355	535	138
65-200 A	80	65	100	180	225	125	95	320	250	65	14	14	750	330	405	815	355	535	148
65-250 B	80	65	100	200	250	160	120	360	280	80	16	19	820	370	450	850	380	490	194
65-250 A	80	65	100	200	250	160	120	360	280	80	16	19	820	370	450	850	380	490	214
80-160 E	100	80	125	180	225	125	95	320	250	65	14	14	665	330	405	665	335	535	92
80-160 D	100	80	125	180	225	125	95	320	250	65	14	14	665	330	405	665	335	535	98.5
80-160 C1	100	80	125	180	225	125	95	320	250	65	14	14	665	330	405	665	335	535	104
80-160 C	100	80	125	180	225	125	95	320	250	65	14	14	735	330	405	735	355	535	129
80-160 B	100	80	125	180	225	125	95	320	250	65	14	14	780	330	405	815	355	535	143
80-160 A	100	80	125	180	225	125	95	320	250	65	14	14	780	330	405	815	355	535	152
80-200 B	100	80	125	180	250	125	95	345	280	65	16	14	840	355	405	850	380	490	189
80-200 A	100	80	125	180	250	125	95	345	280	65	16								